



EnergyPlus Testing with Building Thermal Envelope and Fabric Load Tests from ANSI/ASHRAE Standard 140-2007

EnergyPlus Version 6.0.0.023

November 2010

Prepared for:

U.S. Department of Energy
Energy Efficiency and Renewable Energy
Office of Building Technologies
Washington, D.C.



Prepared by:

Robert H. Henninger and Michael J. Witte

GARDAnalytics

Energy, Economic and Environmental Research

115 S. Wilke Road, Suite 105
Arlington Heights, IL 60005-1500

USA

www.gard.com

This report is based upon work supported by the Ernest Orlando Lawrence Berkeley National Laboratory and the Department of Energy National Energy Technology Laboratory under award number DE-FC26-06NT42768 by subcontract through the University of Central Florida/Florida Solar Energy Center.

This report was prepared as an account of work sponsored by an agency of the United States Government. Neither the United States Government nor any agency thereof, nor any of their employees, makes any warranty, express or implied, or assumes any legal liability or responsibility for the accuracy, completeness, or usefulness of any information, apparatus, product, or process disclosed, or represents that its use would not infringe privately owned rights. Reference herein to any specific commercial product, process, or services by trade name, trademark, manufacturer, or otherwise does not necessarily constitute or imply its endorsement, recommendation, or favoring by the United States Government or any agency thereof. The views and opinions of authors expressed herein do not necessarily state or reflect those of the United States Government or any agency thereof.

Table of Contents

Section	Page
1 TEST OBJECTIVES AND OVERVIEW	1
1.1 Introduction	1
1.2 Test Type: Comparative - Loads	1
1.3 Test Suite: ANSI/ASHRAE Standard 140-2007	1
1.3.1 Case 600 – Base Case Low Mass Building.....	3
1.3.2 Case 610 – South Shading Test for Low Mass Building	6
1.3.3 Case 620 – East/West Window Orientation Test for Low Mass Building.....	7
1.3.4 Case 630 – East/West Shading Test for Low Mass Building.....	8
1.3.5 Case 640 – Thermostat Setback Test for Low Mass Building	8
1.3.6 Case 650 – Night Ventilation Test for Low Mass Building.....	9
1.3.7 Case 900 –Base Case High Mass Building	10
1.3.8 Case 910 –South Shading Test for High Mass Building.....	10
1.3.9 Case 920 – East/West Window Orientation Test for High Mass Building.....	11
1.3.10 Case 930 – East/West Shading Test for High Mass Building	11
1.3.11 Case 940 – Thermostat Setback Test for High Mass Building.....	11
1.3.12 Case 950 – Night Ventilation Test for High Mass Building	11
1.3.13 Case 960 – Sunspace Test	11
1.3.14 Case 600FF – Free Floating Temperature Test for Base Case Low Mass Building	12
1.3.15 Case 650FF – Free Floating Temperature Test for Base Case Low Mass Building with Night Ventilation.....	12
1.3.16 Case 900FF – Free Floating Temperature Test for Base Case High Mass Building.....	13
1.3.17 Case 950FF – Free Floating Temperature Test for Base Case High Mass Building with Night Ventilation	13
1.3.18 Case 195 – Indepth Test of Solid Conduction Problem for Low Mass Building	13
1.4 Modeling Notes	13
2 RESULTS AND DISCUSSION	15
2.1 Comparison of Changes that Occurred Between Versions of EnergyPlus.....	19
3 CONCLUSIONS	23
4 REFERENCES	25

Table of Contents

Section	Page
APPENDIX A CHARTS COMPARING ENERGYPLUS RESULTS WITH OTHER WHOLE BUILDING ENERGY SIMULATION PROGRAMS	
APPENDIX B TABLES COMPARING ENERGYPLUS RESULTS WITH OTHER WHOLE BUILDING ENERGY SIMULATION PROGRAMS	
APPENDIX C DELTA CHARTS COMPARING ENERGYPLUS RESULTS WITH OTHER WHOLE BUILDING ENERGY SIMULATION PROGRAMS	
APPENDIX D ADDITIONAL BASIC AND IN-DEPTH TEST CHARTS COMPARING ENERGYPLUS RESULTS WITH OTHER WHOLE BUILDING ENERGY SIMULATION PROGRAMS	
APPENDIX E HISTORICAL CHANGES IN BESTEST RESULTS FOR VARIOUS RELEASES OF ENERGYPLUS	
APPENDIX F ANSI/ASHRAE STANDARD 140-2007 OUTPUT FORM – MODELING NOTES	

1 TEST OBJECTIVES AND OVERVIEW

1.1 Introduction

This report describes the modeling methodology and results for testing done of building thermal envelope and fabric tests designated as Cases 195 through 960 of ANSI/ASHRAE Standard 140-2007 titled *Standard Method of Test for the Evaluation of Building Energy Analysis Computer Programs* with the EnergyPlus Version 6.0.0.023. The results of EnergyPlus are also compared with results from several other whole building energy analysis programs that simulated the same test cases.

1.2 Test Type: Comparative - Loads

Comparative tests compare a program to itself or to other simulation programs. This type of testing accomplishes results on two different levels, both validation and debugging.

From a validation perspective, comparative tests will show that EnergyPlus is computing solutions that are reasonable compared to other energy simulation programs. This is a very powerful method of assessment, but it is no substitute for determining if the program is absolutely correct since it may be just as equally incorrect as the benchmark program or programs. The biggest strength of comparative testing is the ability to compare any cases that two or more programs can model. This is much more flexible than analytical tests when only specific solutions exist for simple models, and much more flexible than empirical tests when only specific data sets have been collected for usually a very narrow band of operation. The ANSI/ASHRAE Standard 140-2007 procedures discussed below take advantage of the comparative test method and have the added advantage that for the specific tests included in ANSI/ASHRAE Standard 140-2007 have already been run by experts of the other simulation tools.

Comparative testing is also useful for field-by-field input debugging. Energy simulation programs have so many inputs and outputs that the results are often difficult to interpret. To ascertain if a given test passes or fails, engineering judgment or hand calculations are often needed. Field by field comparative testing eliminates any calculational requirements for the subset of fields that are equivalent in two or more simulation programs. The equivalent fields are exercised using equivalent inputs and relevant outputs are directly compared.

1.3 Test Suite: ANSI/ASHRAE Standard 140-2007

The tests described in Section 5.2 of ANSI/ASHRAE Standard 140-2007, *Standard Method of Test for the Evaluation of Building Energy Analysis Computer Programs* (ANSI/ASHRAE 2007), were performed. This suite of tests is based on work previously performed under an earlier project sponsored by the International Energy Agency (IEA) titled *Building Energy*

Simulation Test (BESTEST) and Diagnostic Method (IEA 1995). As stated in its Foreword, Standard 140-2007 is a standard method of test that “can be used for identifying and diagnosing predictive differences from whole building energy simulation software that may possibly be caused by algorithmic differences, modeling limitations, input differences, or coding errors.”

The following tests were performed as specified with modeling notes and other reports generated as shown in the Standard:

- BASE Case (Case 600, Section 5.2.1 of Standard)
- BASIC Tests (Section 5.2.2 of Standard)
 - Low mass tests (Cases 610 to 650),
 - High mass tests (Cases 900 to 960)
 - Free float tests (Cases 600FF, 650FF, 900FF and 950FF)
- IN-DEPTH tests (Section 5.2.3 of Standard)
 - Cases 195 to 320
 - Cases 395 to 440
 - Cases 800 and 810

The EnergyPlus test results are compared to the results of all programs that completed and reported test results, including ESP, BLAST-3-193, DOE2.1D, SRES/SUN, SERIRES, S3PAS, TRNSYS and TASE. Although not part of the original set of results, results for later versions of BLAST and DOE2 have also been added for completeness -- BLAST-3.0-334 and DOE2.1E.

A brief description of the BASE Case, BASIC Test Cases and Case 195 are presented in the following sections. For details of the other test cases refer to Standard 140.

1.3.1 Case 600 – Base Case Low Mass Building

The basic test building (Figure 1) is a rectangular single zone (8 m wide x 6 m long x 2.7 m high) with no interior partitions and 12 m² of windows on the south exposure. The building is of lightweight construction with characteristics as described below. For further details refer to Section 5.2.1 of ANSI/ASHRAE Standard 140-2007.

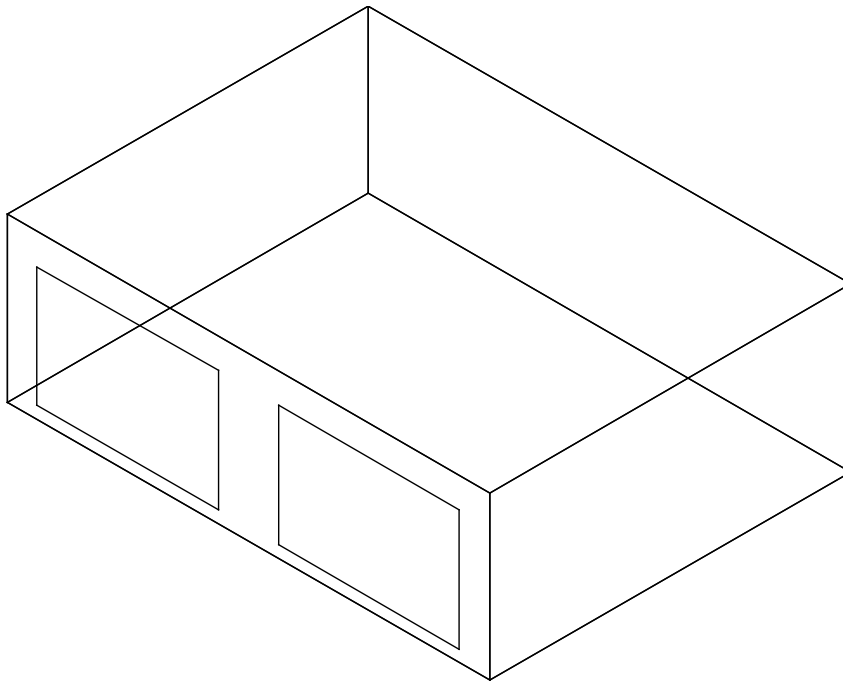

Figure 1 Base Building (Case 600) - Isometric View of Southeast Corner with Windows on South Wall

Wall Construction (light weight mass)

Element	k (W/m-K)	Thickness (m)	U (W/m ² -K)	R (m ² -K/W)	Density (kg/m ³)	Cp (J/kg-K)
Int. Surface Coeff.			8.290	0.121		
Plasterboard	0.160	0.012	13.333	0.075	950	840
Fiberglass Quilt	0.040	0.066	0.606	1.650	12	840
Wood Siding	0.140	0.009	15.556	0.064	530	900
Ext. Surface Coeff.			29.300	0.034		
Overall, air-to-air			0.514	1.944		

Roof Construction (light weight mass)

Element	k (W/m-K)	Thickness (m)	U (W/m ² -K)	R (m ² -K/W)	Density (kg/m ³)	Cp (J/kg-K)
Int. Surface Coeff.			8.290	0.121		
Plasterboard	0.160	0.010	16.000	0.063	950	840
Fiberglass Quilt	0.040	0.1118	0.358	2.794	12	840
Roof Deck	0.140	0.019	7.368	0.136	530	900
Ext. Surface Coat			29.300	0.034		
Overall, air-to-air			0.318	3.147		

Floor Construction (light weight mass)

Element	k (W/m-K)	Thickness (m)	U (W/m ² -K)	R (m ² -K/W)	Density (kg/m ³)	Cp (J/kg-K)
Int. Surface Coeff.			8.290	0.121		
Timber Flooring	0.140	0.025	5.600	0.179	650	1200
Insulation	0.040	1.003	0.040	25.075		
Overall, air-to-air			0.039	25.374		

Window Properties

Extinction coefficient	0.0196/mm
Number of panes	2
Pane thickness	3.175 mm
Air-gap thickness	13 mm
Index of refraction	1.526
Normal direct-beam transmittance through one pane	0.86156
Thermal Conductivity of glass	1.06 W/mK
Conductance of each glass pane	333 W/m ² K
Combined radiative and convective coefficient of air gap	6.297 W/ m ² K
Exterior combined surface coefficient	21.00 W/ m ² K
Interior combined surface coefficient	8.29 W/ m ² K
U-value from interior air to ambient air	3.0 W/ m ² K
Hemispherical infrared emittance of ordinary uncoated glass	0.9
Density of glass	2500 kg/m ³
Specific heat of glass	750 J/kgK
Interior shade devices	None
Double-pane shading coefficient at normal incidence	0.907
Double-pane solar heat gain coefficient at normal incidence	0.789

There is 0.2 m of wall below the window and 0.5 m of wall above the window.

Windows are described in EnergyPlus using the Windows 5 format. Additional glass properties are required for the front side and back side. In consultation with F. Winkelmann of LBNL, it was recommended that the window described above for the ANSI/ASHRAE Standard 140-2007 test be modeled as follows in EnergyPlus:

WindowMaterial:Glazing,

Glass Type 1,	!- Name
SpectralAverage,	!- Optical Data Type
,	!- Window Glass Spectral Data Set Name
0.003175,	!- Thickness {m}
0.86156,	!- Solar Transmittance at Normal Incidence
0.07846,	!- Front Side Solar Reflectance at Normal Incidence
0.07846,	!- Back Side Solar Reflectance at Normal Incidence
0.91325,	!- Visible Transmittance at Normal Incidence
0.08200,	!- Front Side Visible Reflectance at Normal Incidence
0.08200,	!- Back Side Visible Reflectance at Normal Incidence
0.0,	!- Infrared Transmittance at Normal Incidence
0.84,	!- Front Side Infrared Hemispherical Emissivity
0.84,	!- Back Side Infrared Hemispherical Emissivity
1.06;	!- Conductivity {W/m-K}

WindowMaterial:Gas,

Air Space Resistance,	!- Name
AIR,	!- Gas Type
0.013	!- Thickness {m}

Construction,

Double Pane Window,	!- Name
Glass Type 1,	!- Outside Layer
Air Space Resistance,	!- Layer 2
Glass Type 1;	!- Layer 3

Infiltration: 0.5 air change/hour

Internal Load: 200 W continuous, 60% radiative, 40% convective, 100% sensible

Mechanical System: 100% convective air system, 100% efficient with no duct losses and no capacity limitation, no latent heat extraction, non-proportional-type dual setpoint thermostat with deadband, heating $<20^{\circ}\text{C}$, cooling $>27^{\circ}\text{C}$

Soil Temperature: 10C continuous

1.3.2 Case 610 – South Shading Test for Low Mass Building

Case 610 uses the Base Building modeled in Case 600 and adds a 1 m horizontal overhang across the entire length of south wall over the south facing windows at the roof level. See Figure 2. All other characteristics of the building were identical to the Base Case building. This case tests the ability of a program to treat shading of a south exposed window.

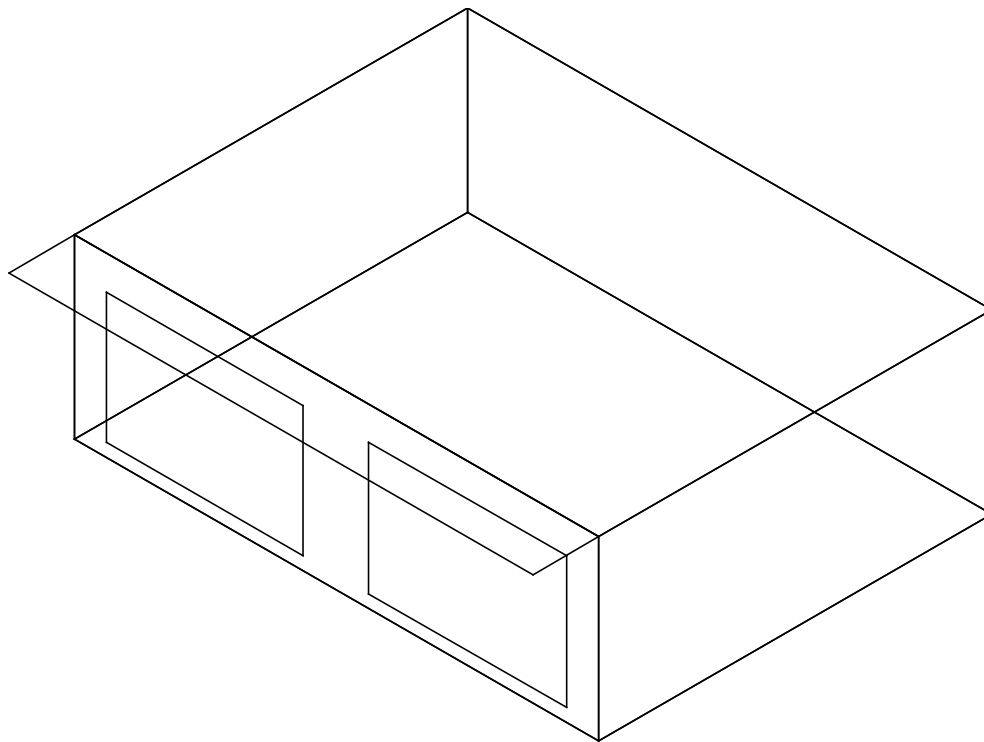

**Figure 2 Base Building with South Shading (Case 610) -
Isometric View of Southeast Corner**

1.3.3 Case 620 – East/West Window Orientation Test for Low Mass Building

Case 620 uses the Base Building modeled in Case 600 with the following changes:

- a) The window orientation was modified as shown in Figure 3 such that 6 m² of window area was added to both the east and west walls. The window properties are exactly the same as in Case 600
- b) The south windows were eliminated and replaced with the wall construction used throughout the building

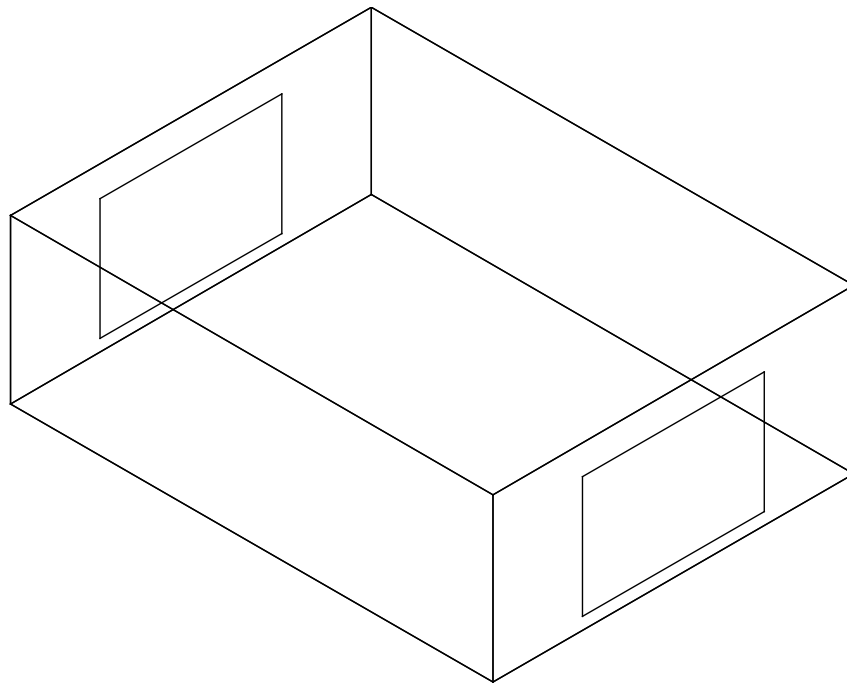

Figure 3 Building with East/West Window Orientation (Case 620) - Isometric View of Southeast Corner

1.3.4 Case 630 – East/West Shading Test for Low Mass Building

Case 630 is exactly the same as Case 620 except that a shade overhang and shade fins were added around the east and west window. See Figure 4. A 1 m horizontal overhang is located at the roof level and extends across the 3 m width of each window. The 1 m wide right and left vertical shade fins are located a edge of each window and extend from the roof down to the ground.

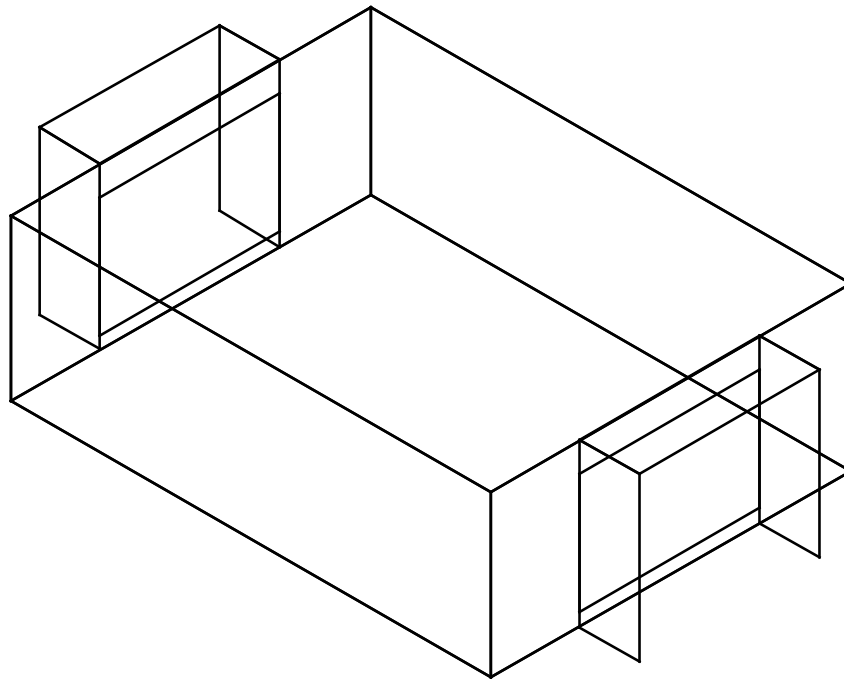

Figure 4 Building with East/West Window Orientation and Shade Overhang and Shade Fins added (Case 630) - Isometric View of Southeast Corner

1.3.5 Case 640 – Thermostat Setback Test for Low Mass Building

Case 640 is identical to the Base Case building of Case 600 except the following heating and cooling temperature setback schedule with a non-proportional thermostat was used:

- a) From 2300 hours to 0700 hours, heat = on if zone temperature $<10^{\circ}\text{C}$
- b) From 0700 hours to 2300 hours, heat = on if zone temperature $<20^{\circ}\text{C}$
- c) All hours, cool = on if zone temperature $>27^{\circ}\text{C}$
- d) Otherwise, mechanical equipment is off.

See Figure 1 for schematic of building.

1.3.6 Case 650 – Night Ventilation Test for Low Mass Building

Case 650 is identical to the Base Case building of Case 600 except the following scheduled night time ventilation and heating and cooling temperature control was used:

- a) From 1800 hours to 0700 hours, vent fan = on
- b) From 0700 hours to 1800 hours, vent fan = off
- c) Heating is always off
- d) From 0700 hours to 1800 hours, cool = on if zone temperature $>27^{\circ}\text{C}$, otherwise cool = off
- e) From 1800 hours to 0700 hours, cool = off
- f) Vent fan capacity = 1703.16 standard m^3/h (in addition to specified infiltration rate)
- g) Waste heat from fan = 0.

See Figure 1 for schematic of building.

1.3.7 Case 900 –Base Case High Mass Building

The 900 series of tests use the same building model as was used for the series 600 tests except that the wall and floor construction were changed to use heavier materials. Everything else with the building remained the same. The characteristics of the heavier mass wall and floor are as follows:

Wall Construction (heavy weight mass)

Element	k (W/m-K)	Thickness (m)	U (W/m ² -K)	R (m ² -K/W)	Density (kg/m ³)	Cp (J/kg-K)
Int. Surface Coeff.			8.290	0.121		
Concrete Block	0.510	0.100	5.100	0.196	1400	1000
Foam Insulation	0.040	0.0615	0.651	1.537	10	1400
Wood Siding	0.140	0.009	15.556	0.064	530	900
Ext. Surface Coeff.			29.300	0.034		
Overall, air-to-air			0.512	1.952		

Floor Construction (heavy weight mass)

Element	k (W/m-K)	Thickness (m)	U (W/m ² -K)	R (m ² -K/W)	Density (kg/m ³)	Cp (J/kg-K)
Int. Surface Coeff.			8.290	0.121		
Concrete Slab	1.130	0.080	14.125	0.071	1400	1000
Insulation	0.040	1.007	0.040	25.175		
Overall, air-to-air			0.039	25.366		

See Figure 1 for schematic of building for Case 900.

1.3.8 Case 910 –South Shading Test for High Mass Building

Case 910 uses the high mass Base Building modeled in Case 900 except that a 1 m horizontal overhang was added to the entire length of south wall over the south facing windows at the roof level. See Figure 2. All other characteristics of the building were identical to the high mass Base Building of Case 900. This case tests the ability of a program to treat shading of a south exposed window. This case is identical to Case 610 except for high mass walls and floor.

1.3.9 Case 920 – East/West Window Orientation Test for High Mass Building

Case 920 is identical to Case 620 except for high mass walls and floor.

1.3.10 Case 930 – East/West Shading Test for High Mass Building

Case 930 is identical to Case 630 except for high mass walls and floor.

1.3.11 Case 940 – Thermostat Setback Test for High Mass Building

Case 940 is identical to Case 640 except for high mass walls and floor.

1.3.12 Case 950 – Night Ventilation Test for High Mass Building

Case 950 is identical to case 650 except for high mass walls and floor.

1.3.13 Case 960 – Sunspace Test

Case 960 simulates a passive solar building consisting of two zones (a back-zone and a sun-zone) separated by a common interior wall (Figure 5).

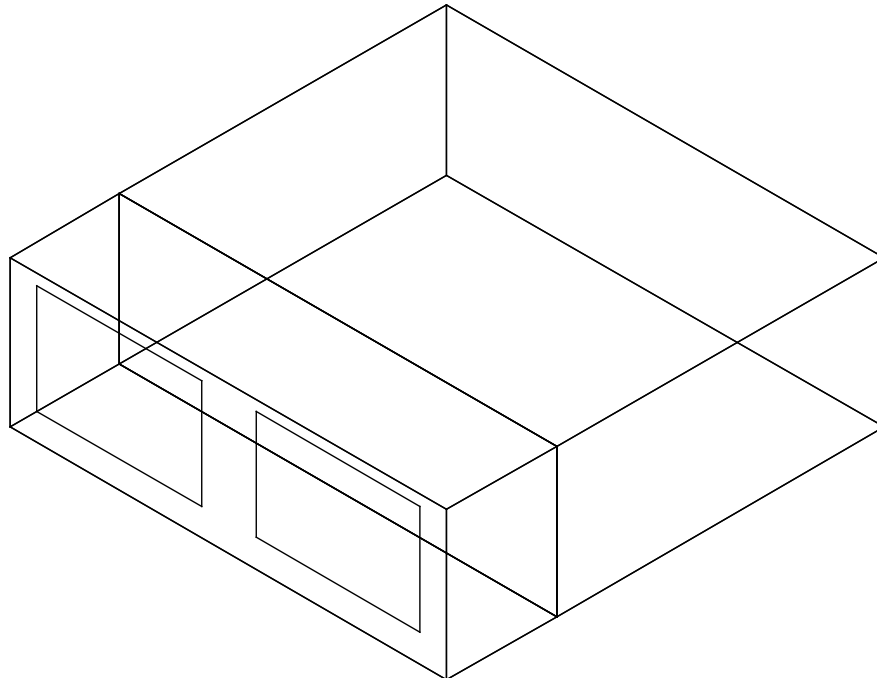

Figure 5 Sunspace Building with Back-Zone and Sun-Zone (Case 960) - Isometric View of Southeast Corner

Back Zone: The geometric and thermal properties of the back-zone are exactly the same as for Case 600 except that the south wall and windows are replaced with the common wall. Infiltration and internal load in the back-zone is also the same as in Case 600.

Common Wall: Material properties of the common wall are as follows:

Element	k (W/m-K)	Thickness (m)	U (W/m ² -K)	R (m ² -K/W)	Density (kg/m ³)	Cp (J/kg-K)
Common Wall	0.510	0.200	2.55	0.392	1400	1000

Sun-Zone: The sun-zone is 2 m deep by 8 m wide by 2.7 m high. The back (north) wall of the sun-zone is the common wall. The south wall of the sun-zone contains two 6 m² windows that are identical to the windows in Case 900 except that they are raised to a level of 0.5 m above the ground. The thermal and physical properties of the sun-zone are the same as case 900 with the following exceptions:

- a) Zone depth is 2 meters.
- b) The north wall has been replaced with the common wall.
- c) The east and west walls (end-walls) are 5.4 m² each.
- d) The volume of the sun-zone is 43.2 m³.
- e) Infiltration rate is 0.5 air changes per hour.
- f) Internal heat gain = 0 W.
- g) Heating and cooling control strategy as follows:
 Sun-zone has no space conditioning system (free floating).
 Back-zone is controlled the same as for case 600.

1.3.14 Case 600FF – Free Floating Temperature Test for Base Case Low Mass Building

Case 600FF is the same as Case 600 except that there is no mechanical heating or cooling system.

1.3.15 Case 650FF – Free Floating Temperature Test for Base Case Low Mass Building with Night Ventilation

Case 650FF is the same as Case 650 except that there is no mechanical heating or cooling system.

1.3.16 Case 900FF – Free Floating Temperature Test for Base Case High Mass Building

Case 900FF is the same as Case 900 except that there is no mechanical heating or cooling system.

1.3.17 Case 950FF – Free Floating Temperature Test for Base Case High Mass Building with Night Ventilation

Case 950FF is the same as Case 950 except that there is no mechanical heating or cooling system.

1.3.18 Case 195 – Indepth Test of Solid Conduction Problem for Low Mass Building

Case 195 is the same as case 600 with the following exceptions:

- a) South wall contains no windows and is entirely constructed of the Lightweight mass exterior wall construction described in Section 1.2.1.
- b) Infiltration Rate = 0
- c) Internal Gains = 0
- d) Thermostat control is “20,20 bang-bang”
Heat = on if temperature < 20C
Cool = on if temperature > 20C
- e) Interior and exterior surface emissivity and absorptance set = 0.1

1.4 Modeling Notes

The specifications as presented in Section 5 - Test Procedures of ANSI/ASHRAE Standard 140-2007 were followed to prepare the EnergyPlus models for the test cases described above. In some cases the specification provided redundant input values for a particular element of the building due to the fact different programs require different inputs. The following notes are presented regarding preparation of EnergyPlus IDF files:

- a) The weather file used for all simulations was taken from a CD that was provided along with Standard 140-2007. The weather file is labeled DRYCOLD.TMY and contains hourly weather for an entire year which is characterized as “cold clear winters/hot dry summers.”
- b) Although the Standard spelled out in detail the exterior and interior radiative and convective surface properties, these were not used. The Standard indicated that if your program automatically calculates the exterior and interior film coefficients, then these radiative and convective input values were to be disregarded.

- c) The material layers for walls, floors and roofs were specified using the Material object except for the floor insulation which was described using the Material:NoMass object. The opaque surface radiative properties listed in the Material object were defined in the Standard and were set as follows:
- | | |
|---------------------|------|
| Thermal Emissivity | 0.90 |
| Solar Absorptance | 0.60 |
| Visible Absorptance | 0.60 |
- d) The glass for windows was specified using the Window:MaterialGlazing and Window:MaterialGas objects. Certain input variables listed in the Window:MaterialGlazing object were not defined in the Standard and were set as follows:
- | | |
|-----------------------|---------|
| Visible Transmittance | 0.91325 |
|-----------------------|---------|
- e) The convergence variables in the Building object were set as follows:
- | | |
|---|---------------|
| Loads Convergence Tolerance Value | 3.9999999E-02 |
| Temperature Convergence Tolerance Value | 4.0000002E-03 |
- f) To get the shade calculations to work for the window overhang test cases, the following variables in the Building object had to be set:
- Solar Distribution = FullInteriorAndExterior
- Same was true for cases with window fins.
- g) The following objects were set to:
- Surface Convection Algorithm:Inside = Detailed (v5.0.0 and earlier)
 Surface Convection Algorithm:Inside = TARP (v6.0.0)
 Surface Convection Algorithm:Outside = DOE-2
- h) To get the dual setpoint with deadband thermostat (Type=4) to work, the following object had to be specified:
- ZoneCapacitanceMultiplier = 1 (v5.0.0 and earlier)
 Not included and left to default (v6.0.0)
- i) The ZoneHVAC:IdealLoadsAirSystem (called PURCHASED AIR system in earlier versions) was used to model the mechanical system.
- j) All simulations were done using a Timestep = 4; output results were reported hourly.

2 RESULTS AND DISCUSSION

The results of the EnergyPlus Loads comparison with other whole building energy analysis programs that participated in the comparison are summarized on a set of charts

Code Name	Computer Program	Developer	Implemented by
BLAST	BLAST-3.0 level 193 v.1	CERL, U.S.	NREL, U.S. Politecnico, Torino, Italy
DOE2.1D	DOE2.1D 14	LANL/LBL, U.S.	NREL, U.S.
ESP	ESP-RV8	Strathclyde University, U.K.	De Montfort University, U.K.
SRES/SUN	SERIRES/SUNCODE 5.7	NREL/Ecotope, U.S.	NREL, U.S.
SERIRES	SERIRES 1.2	NREL, U.S. BRE, U.K.	BRE, U.K.
S3PAS	S3PAS	University of Sevilla, Spain	University of Sevilla, Spain
TASE	TASE	Tampere University, Finland	Tampere University, Finland
TRNSYS	TRNSYS 13.1	University of Wisconsin, U.S.	BRE, U.K. Vrije Universiteit (VUB), Brussels, Belgium
DOE2.1E	DOE2.1E	LANL/LBL, U.S.	GARD Analytics, U.S. using NREL input files
DOE2.1E- RevWindow	DOE2.1E-RevWindow	LANL/LBL, U.S.	GARD Analytics, U.S. Uses Window 4 data file which more closely matches specification
BLAST3.0-334	BLAST-3.0 level 334	CERL, U.S.	GARD Analytics, U.S. using NREL input files
ENERGYPLUS	EnergyPlus ver. 6.0.0.023, Nov 2010	U.S. Dept. of Energy	GARD Analytics, U.S.

presented in Appendix A. The nomenclature for the various programs referred to on these charts along with the program author and modeler responsible for using the program as part of the BESTEST project are presented on the previous page. Results for later versions of BLAST (3.0 level 334) and DOE2 (2.1E) which were not part of the original BESTEST exercise have also been added.

Appendix A contains a series of charts that compare the results of EnergyPlus with other programs. The results for other programs have been updated to reflected the results reported in ANSI/ASHRAE Standard 140-2007. The charts are presented in the following order:

- Low Mass Building, Annual Heating, Cases 600, 610, 620, 630, 640, 650
- Low Mass Building, Annual Cooling, Cases 600, 610, 620, 630, 640, 650
- Low Mass Building, Peak Heating, Cases 600, 610, 620, 630, 640, 650
- Low Mass Building, Peak Cooling, Cases 600, 610, 620, 630, 640, 650
- High Mass Building, Annual Heating, Cases 900, 910, 920, 930, 940, 950, 960
- High Mass Building, Annual Cooling, Cases 900, 910, 920, 930, 940, 950, 960
- High Mass Building, Peak Heating, Cases 900, 910, 920, 930, 940, 950, 960
- High Mass Building, Peak Cooling, Cases 900, 910, 920, 930, 940, 950, 960
- Free Floating Zone Temperature, Maximum Temperature, Cases 600FF, 900FF, 650FF, 950FF, 960 Sunspace
- Free Floating Zone Temperature, Minimum Temperature, Cases 600FF, 900FF, 650FF, 950FF, 960 Sunspace
- Low Mass Building, Low Absorptances, No Windows, Case 195.

Results are also summarized in tabular format in Appendix B.

With EnergyPlus version 1.3.0.018 a new SITE ATMOSPHERIC VARIATION input object became available (beginning with EnergyPlus 3.0.0 the name of this object changed to Site:HeightVariation) to simulate changes in outside air temperature and wind speed that typically occur vertically across building surfaces versus the outdoor air temperature and wind speed that are obtained each hour from the weather file. Typically the meteorological wind speed is measured in an open field at 10m above the ground and meteorological air temperature is measured at 1.5m above ground level. To accommodate atmospheric variation EnergyPlus now automatically calculates the local outdoor air temperature and wind speed separately for each zone and surface exposed to the outdoor environment. The zone centroid or surface centroid are used to determine the height above ground. Only local outdoor air temperature and wind speed are currently calculated because they are important factors for the exterior convection calculation for surfaces and can also be factors in the zone infiltration and ventilation calculations.

Since the Standard 140 instructions indicate that if the program being tested automatically calculates exterior surface convection coefficients then this is the method that should be used to model the various test cases, the SITE ATMOSPHERIC VARIATION object was allowed to be active for all of the test cases simulated with EnergyPlus 1.3.0.018 and later versions with the following default inputs for a country terrain:

SITE ATMOSPHERIC VARIATION,

- 0.14, !- Wind Speed Profile Exponent
- 270, !- Wind Speed Profile Boundary Layer Thickness {m}
- 0.0065; !- Air Temperature Gradient Coefficient {K/m}

The result was that there were small changes in the EnergyPlus 1.3.0.018 results compared to results from previous EnergyPlus releases.

The methodology for handling solar diffuse through a window was completely reworked in EnergyPlus 2.1.0.012 and was changed from uniform interior distribution of transmitted diffuse solar to distribution based on approximate view factors between transmitting windows and zone heat transfer surfaces. All tests showed varying degrees of change compared to the previous EnergyPlus 2.0.0.025 release. See further discussion in Section 2.1 below.

One measure of comparison as to how well EnergyPlus predicted thermal loads compared to the other programs is to see if the results fall within the range of spread of results for other programs. This can be seen visually with the charts included in Appendix A where the annual heating, annual cooling, peak heating and peak cooling are displayed as a series of bars for the series 600 and series 900 cases that were analyzed by all programs. Appendix B shows the same results but in tabular format and also includes a row for each comparison indicating a YES or NO if EnergyPlus was within range. For the 62 individual comparisons that were performed, the EnergyPlus results were within the range of spread of results for the other programs for all cases except the following:

Test	Building Type	Feature Being Tested	Output Parameter	Range of Other Programs	EnergyPlus
620	Low Mass	East/West Windows	Annual Heating	4.61 to 5.94 MWh	4.51 MWh
630	Low Mass	East/West Windows with Shading	Annual Heating	5.05 to 6.47 MWh	4.81 MWh
640	Low Mass	Thermostat Setback	Annual Heating	2.75 to 3.80 MWh	2.67 MWh
900	High Mass	South Windows	Annual Heating	1.17 to 2.04 MWh	1.16 MWh
910	High Mass	South Windows with Shading	Annual Heating	1.51 to 2.28 MWh	1.43 MWh
920	High Mass	East/West Windows	Annual Heating	3.26 to 4.30 MWh	3.09 MWh
930	High Mass	East/West Windows with Shading	Annual Heating	4.14 to 5.34 MWh	3.79 MWh
940	High Mass	Thermostat Setback	Annual Heating	0.79 to 1.41 MWh	0.73 MWh

For the free floating cases where 10 additional comparisons were made, the maximum and minimum zone temperatures predicted by EnergyPlus were within the range of spread for all the programs except for:

Test	Building Type	Feature Being Tested	Output Parameter	Range of Other Programs	EnergyPlus
650FF	Low Mass	Night Ventilation	Minimum Zone Temp.	-23.0 to -21.0 C	-23.1 C
950FF	High Mass	Night Ventilation	Minimum Zone Temp.	-20.2 to -17.8 C	-20.3 C

For the solid conduction problem (case 195) it was not possible to make a broad comparison since there was only one program recognized by ASHRAE as having a valid result.

A series of “Delta Charts” were also generated which compare the difference in results between certain cases in order to isolate the sensitivity of each program to changes in building features such as mass construction, addition of windows with and without shading, thermostat setback, ventilation cooling, etc. The “Delta Charts” comparing EnergyPlus results with other programs are presented in Appendix C. A visual comparison of EnergyPlus results compared to other programs indicates significant difference for:

Delta Test	Building Type	Feature Being Tested	Output Parameter	Range of Other Programs	EnergyPlus
(620 – 600)	Low Mass	E/W Window vs. S Window	Peak Cooling	-2.56 to -1.72 KW	-2.67 KW
(650 – 600)	Low Mass	Vent Cooling vs. No Vent Cooling	Annual Cooling	-1.42 to -1.24 MWh	-1.47 MWh
(650 – 600)	Low Mass	Vent Cooling vs. No Vent Cooling	Peak Cooling	-0.163 to -0.085 KW	-0.199 KW
(920 – 900)	High Mass	East/West Windows	Annual Heating	1.99 to 2.50 MWh	1.92 MWh
(940 – 640)		Setback (High Mass) vs. Setback (Low Mass)	Peak Heating	-1.252 to -0.230 KW	-1.481 KW
(950 – 650)		Vent Cooling	Peak Cooling	-3.21 to -3.99 KWh	-4.03 KW

Additional BASIC and IN-DEPTH test charts comparing EnergyPlus results to those of other programs are presented in Appendix D. These almost 100 additional comparisons are designed to isolate the effects of specific algorithms and a program’s ability to model building envelope loads for a non-deadband on/off thermostat control configuration with the following variations among cases: no windows, opaque windows, exterior infrared emittance, interior infrared emittance, infiltration, internal gains, exterior shortwave absorptance, south solar gains, interior shortwave absorptance, window orientation, shading devices, and thermostat setpoints. In EnergyPlus version 1.4.0.004 a correction was made to the sunlit area calculation for DOORS which affected the results for Cases 200, 210, 215, 220, 230, 240, 250, 395, 400, 410, 420 and 430 where the windows were replaced with opaque surfaces that had been modeled in EnergyPlus as DOORS. This brought the results for most of these cases back within the range of other programs but still left EnergyPlus results for annual heating in Cases 300 and 310 and the results for peak cooling for Cases 395 and 400 out of range.

With the switch to the DOE-2 outside convection coefficient algorithm in EnergyPlus version 3.1.0.027 annual heating decreased overall and Cases 270 to 320 were now out of range along with peak heating for Cases 300 and 310. The peak cooling results for Cases 395 and 400 were now brought back within the range of other programs.

In EnergyPlus version 4.0.0.024 the algorithms for window convection coefficients changed and as a result, in addition to the changes discussed above for the BASIC and IN-DEPTH tests, the annual heating results for Case 300 moved outside of the range of other programs.

2.1 Comparison of Changes that Occurred Between Versions of EnergyPlus

This section documents the comparative changes that took place in results as modifications were made to the EnergyPlus code or changes were made in the modeling approach. Since the first reporting of EnergyPlus results for BESTEST with version 1.0.0.023 back in August 2001, further capabilities and improvements have been added to EnergyPlus with new releases beginning in June 2002 (version 1.0.1) and continuing through the current release in October 2010 (version 6.0.0.023). The table below summarizes pertinent input file and code changes that were made as the testing progressed with each new public release of EnergyPlus.

Summary of Pertinent EnergyPlus Changes that were Implemented Since Original Testing with Version 1.0.0.023

Version	Input File Changes	Code Changes
1.0.1.001		Change in weather processing file
1.0.1.008		Change in solar position calculation
1.0.1.037		Added ability to input monthly ground reflectance
1.0.1.040	Set monthly ground reflectance to 0.20. Previously defaulted to 0.2 – 0.6 depending on month	
1.0.1.026	Set SHADOW CALCULATIONS = 1; previously defaulted to 20	
1.0.3.006		Changed weather interpolation to previous hour
1.0.3.015		Changed to “half” interpolation for solar radiation
1.1.1.004		Changed surface convection coefficient algorithms
1.2.0		More changes to exterior convection coefficient algorithms
1.3.0.018	Included new SITE ATMOSPHERIC VARIATION object to allow calculation of local outdoor air temperature and wind speed for each exterior surface	
1.3.0.018	For Case 960, changed solar distribution option from FullExterior to FullInteriorAndExterior; also for case 960, corrected the order of coordinates for the common wall	
1.3.0.018	For all cases, began using a new Drycold weather file converted directly from TMY to EPW format with EnergyPlus weather converter; previously used a weather file that was first converted to BLAST format and then to EPW format.	
1.4.0.004		The sunlit area calculation for DOORS was corrected. This affected the results for Cases 200, 210, 215, 220, 230, 240,

		250, 395, 400, 410, 420 and 430 where windows were replaced with an opaque surface which had been modeled as a DOOR. (CR6989)
2.1.0.023		The methodology for handling solar diffuse through a window was completely reworked and was changed from uniform interior distribution of transmitted diffuse solar to distribution based on approximate view factors between transmitting windows and zone heat transfer surfaces. (CR7237)
3.0.0.028		The algorithm for variable system timestep was revised. Changes include uniform system timestep length across zone timestep and stricter management of history terms for zone air conditions.
3.1.0.027	Changed SurfaceConvectionAlgorithm:Outside from Detailed to DOE-2 method.	The default for SurfaceConvectionAlgorithm:Outside was changed from Detailed to DOE-2 method. (CR7703)
4.0.0.013		Algorithms for window convection coefficients were changed (CR7820)
4.0.0.024	For Case 960 the Common Wall (wall between conditioned zone and sunspace) solar absorptance was changed from 0.75 to 0.60 to conform to specification.	
6.0.0.012	Changed SurfaceConvectionAlgorithm:Inside from Detailed to TARP which gives same results; eliminated the ZoneCapacitanceMultiplier object to let it default	

Charts presented in Appendix E show graphically how results changed for the various BESTEST cases with each public release version of EnergyPlus and changes discussed in the above table. Changes in results between the first two releases were sometimes significant (as high as 10%). Some significant changes also occurred with version 1.1.1.004 where surface convection coefficient algorithms were changed.

The results for Case 960 with EnergyPlus version 1.3.0.018 input file changes produced only small changes compared to previous versions.

Changing the weather file conversion procedure produced significant changes. Previously, for all results through version 1.3.0.018, the BESTEST analyses had been done using a BLAST weather file which had been converted into EnergyPlus EPW format using the EnergyPlus weather converter. Since then, the DRYCOLD.TMY weather file provided with Standard 140 has been directly converted into EPW format using the EnergyPlus weather converter. This produced significant changes in results for some test cases as can be seen from the charts in Appendix E where results are shown using EnergyPlus version 1.3.0.018 with both the originally converted weather file (shown on charts as Ver 1.3.0.018) and results with the new weather file (shown on charts as Ver 1.3.0.018 NewWeather). A comparison of the two weather files shows several differences. First, the BLAST version of the BESTEST weather file has Daylight Savings Time option turned on while the EnergyPlus version of the BESTEST weather file has the Daylight Savings Time option turned off. This created differences in results for those test cases which have schedules which change throughout the day, i.e. thermostat setback and nighttime ventilation cases (Cases 640, 650, 650FF, 940, 950 and 950FF). Secondly, there were differences in the hourly outdoor wet-bulb temperature (which produces corresponding changes

in outdoor humidity ratio, relative humidity, enthalpy and density), sky temperature and diffuse and direct solar as indicated below.

	Change in E-Plus Max Difference (C)	Change in E-Plus Average Difference (C)
Outdoor Wet-Bulb Temp	0.33	0.05
Sky Temperature	10.6	3.5
	Change in E-Plus Annual Difference (%)	
Annual Direct Solar	0.11	
Annual Diffuse Solar	4.2	

These changes are undoubtedly due to differences in the psychrometric and solar routines used by the BLAST and EnergyPlus weather conversion programs.

Significant changes also occurred in EnergyPlus version 2.1.0.023 where the methodology for treating window diffuse solar radiation within a zone was changed. The annual and peak heating results were less than those reported with version 2.0.0.025 and annual and peak cooling results were greater than those reported previously. Annual heating changed by as much as -2.7% and annual cooling changed by as much as +7% depending on the test case. Peak heating changed by as much as -0.3% and peak cooling changed by as much as +2.1% depending on the test case.

The change highlighted above for version 3.0.0.028 had only a small impact on results (usually <0.5% change) compared to results obtained with version 2.2.0.023 except for the heating/cooling temperature setback cases 640 and 940. For both cases the annual heating decreased by about 5% while the peak heating decreased by 12-15%. In the case of 640 peak heating, the impact was to move EnergyPlus to within the bounds of the other programs. In the case of 940 annual heating it moved EnergyPlus just outside the range of other programs.

For EnergyPlus version 3.1.0.027, the default value for SurfaceConvectionAlgorithm:Outside was changed from Detailed to DOE-2 method. This change was made because the Detailed method was flawed when applied to small surfaces or subsurfaces which are part of a larger overall building facade. The input files for the test suite were modified to use this new default method. The change to the DOE-2 outside convection coefficient algorithm in EnergyPlus version 3.1.0.027 had the overall result of reducing annual heating results and consequently for 3 additional cases the EnergyPlus annual heating results moved outside the range of the other programs.

For EnergyPlus 4.0.0.013, the window convection coefficient algorithms were changed due to errors which occurred when temperatures were out of range and with one routine where the temperature being passed was in K rather than C.

For EnergyPlus version 4.0.0.024, the solar absorptance for the Common Wall separating the conditioned zone and the sunspace in Case 960 was changed from 0.75 to 0.60, correcting an input error. As a result the annual heating increased by 3.7% and the annual cooling decreased by 4.0% bringing both results closer to the middle of the range of results for the other programs.



3 CONCLUSIONS

EnergyPlus Version 6.0.0.023 was used to model a range of building specifications as specified in ANSI/ASHRAE Standard 140-2007 - *Standard Method of Test for the Evaluation of Building Energy Analysis Computer Programs* and in the *Building Energy Simulation Test (BESTEST) and Diagnostic Method*. The ability of EnergyPlus to predict thermal loads was tested using a test suite of 18 cases which included buildings with both low mass and high mass construction, without windows and with windows on various exposures, with and without exterior window shading, with and without temperature setback, with and without night ventilation, and with and without free floating space temperatures. The annual heating and cooling and peak heating and cooling results predicted by EnergyPlus for 13 different cases were compared to results from 8 other whole building energy simulation programs that participated in an International Energy Agency (IEA) project conducted in February 1995. Maximum and minimum free-floating temperatures were compared for 4 different cases. A solid conduction case was compared to only one other program due to modeling limitations in the other programs. A range of over 100 BASIC and IN-DEPTH test cases were also modeled. When comparing EnergyPlus' results for the BASIC and IN-DEPTH test cases, EnergyPlus was within the range of spread of results for the other 8 programs for all but seven cases. The seven cases outside of range were all less than 15.6% out of bounds.



4 REFERENCES

ANSI/ASHRAE 2007. Standard 140-2007, Standard Method of Test for the Evaluation of Building Energy Analysis Computer Programs, American Society of Heating, Refrigerating and Air-Conditioning Engineers, Atlanta, GA.

EnergyPlus 2010. U.S. Department of Energy, Energy Efficiency and Renewable Energy, Office of Building Technologies. www.energyplus.gov

IEA 1995. *Building Energy Simulation Test (BESTEST) and Diagnostic Method*, National Renewable Energy Laboratory, Golden, Colorado, February 1995.

Appendix A

Charts Comparing EnergyPlus Results with Other Whole Building Energy Simulation Programs

Standard 140-2007 Comparison Low Mass Building Annual Cooling

EnergyPlus Version 6.0.0.023

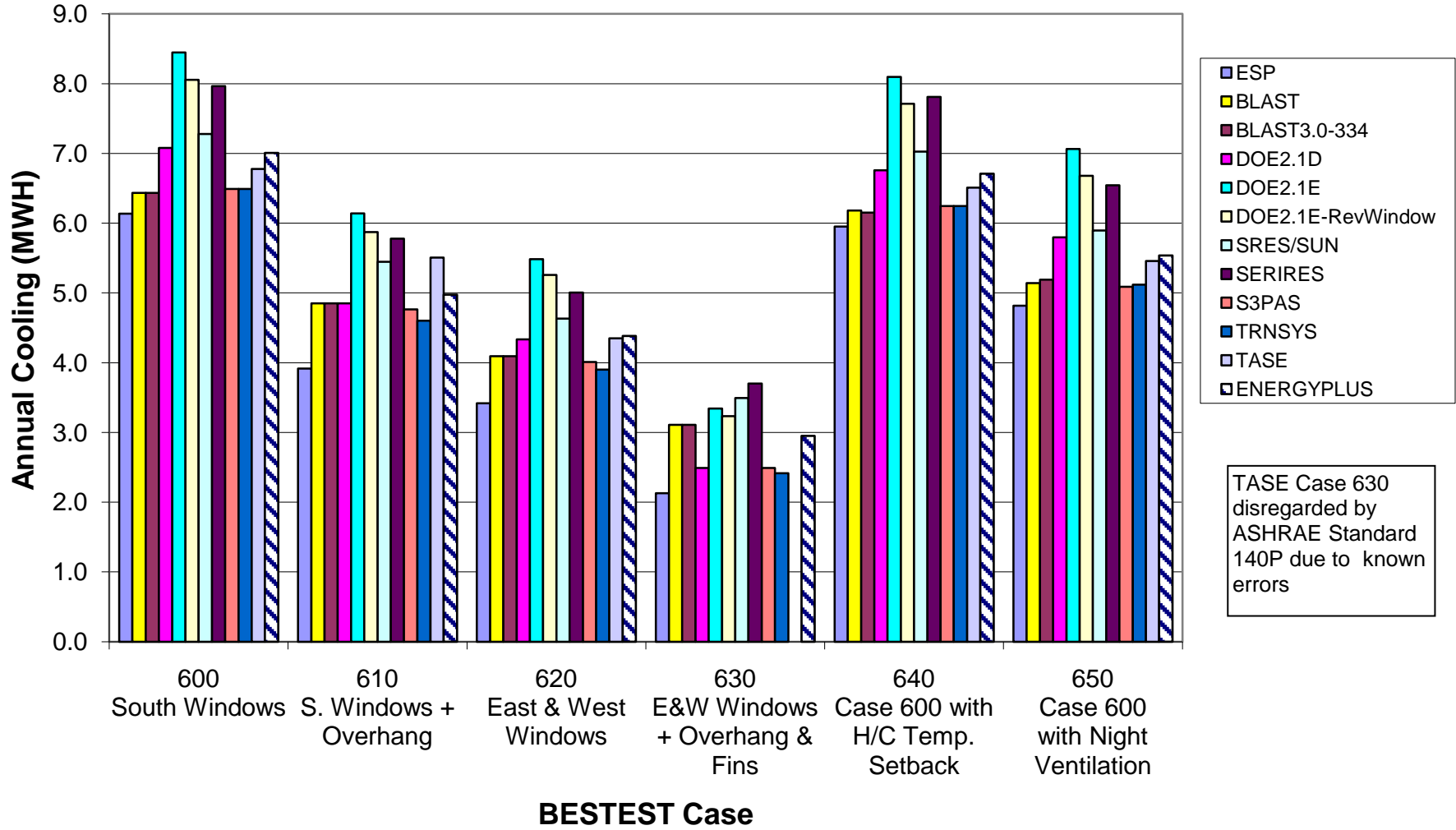

Standard 140-2007 Comparison Low Mass Building Peak Cooling

EnergyPlus Version 6.0.0.023

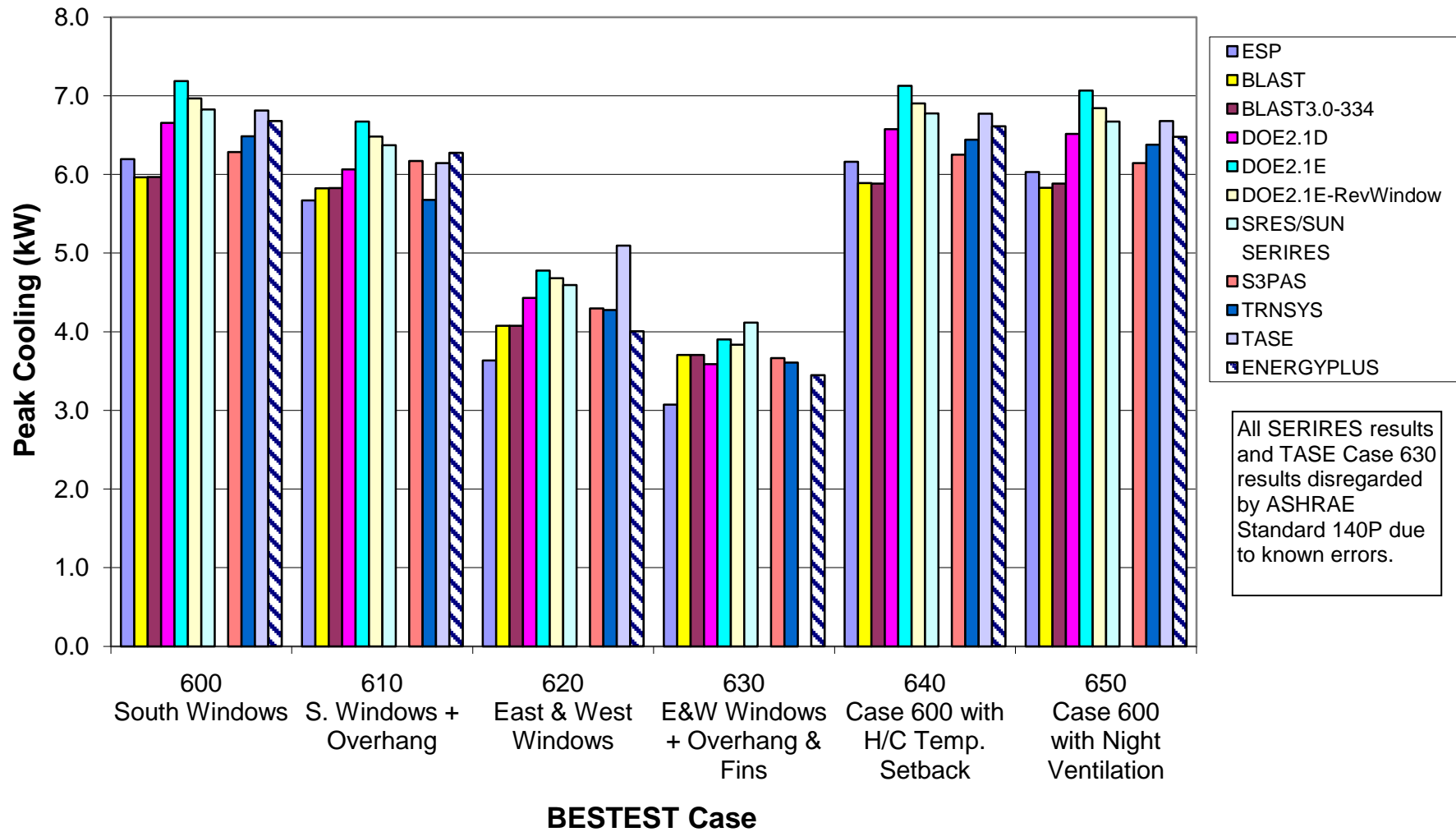

Standard 140-2007 Comparison High Mass Building Annual Heating

EnergyPlus Version 6.0.0.023

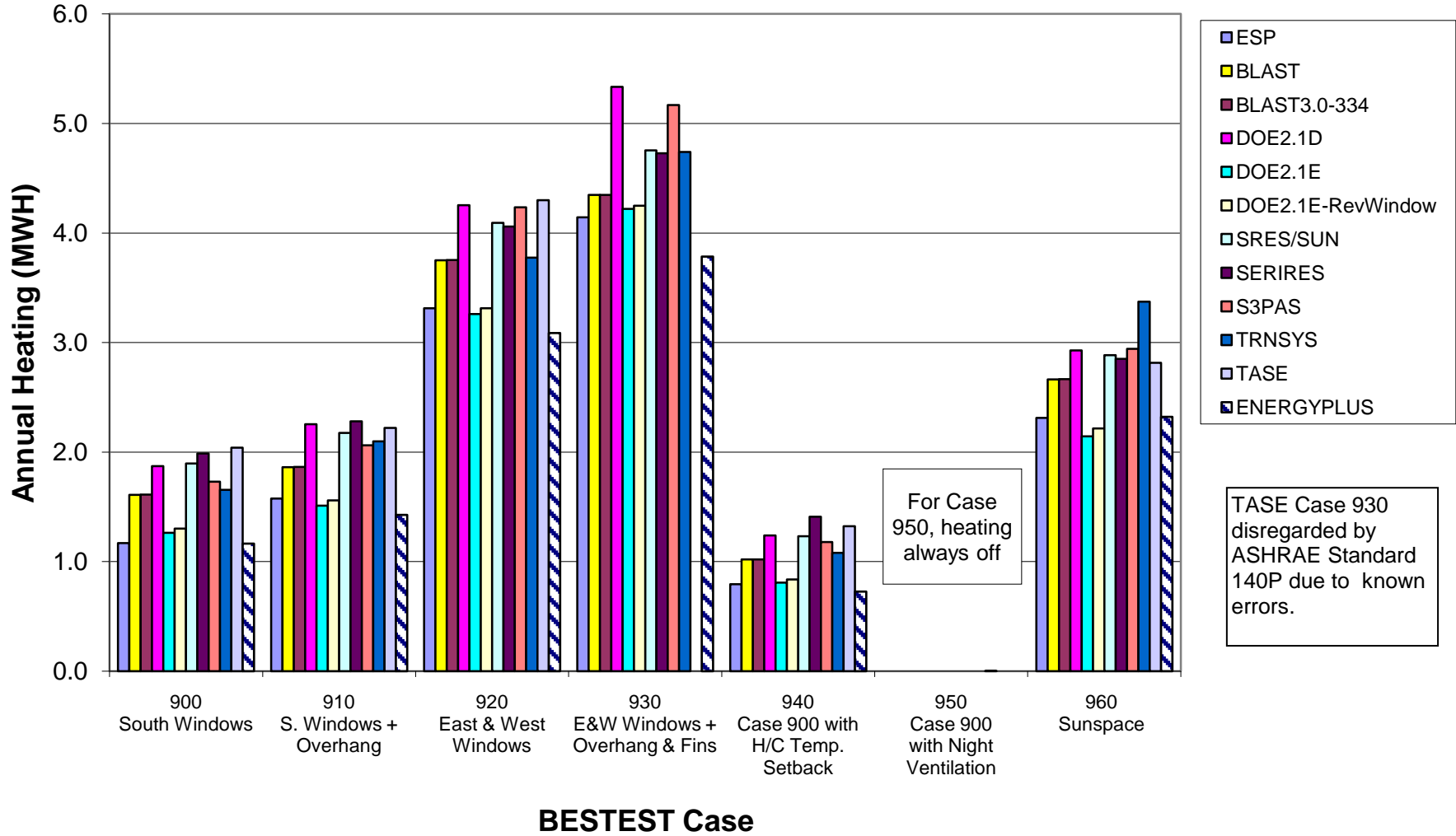

Standard 140-2007 Comparison High Mass Building Annual Cooling

EnergyPlus Version 6.0.0.023

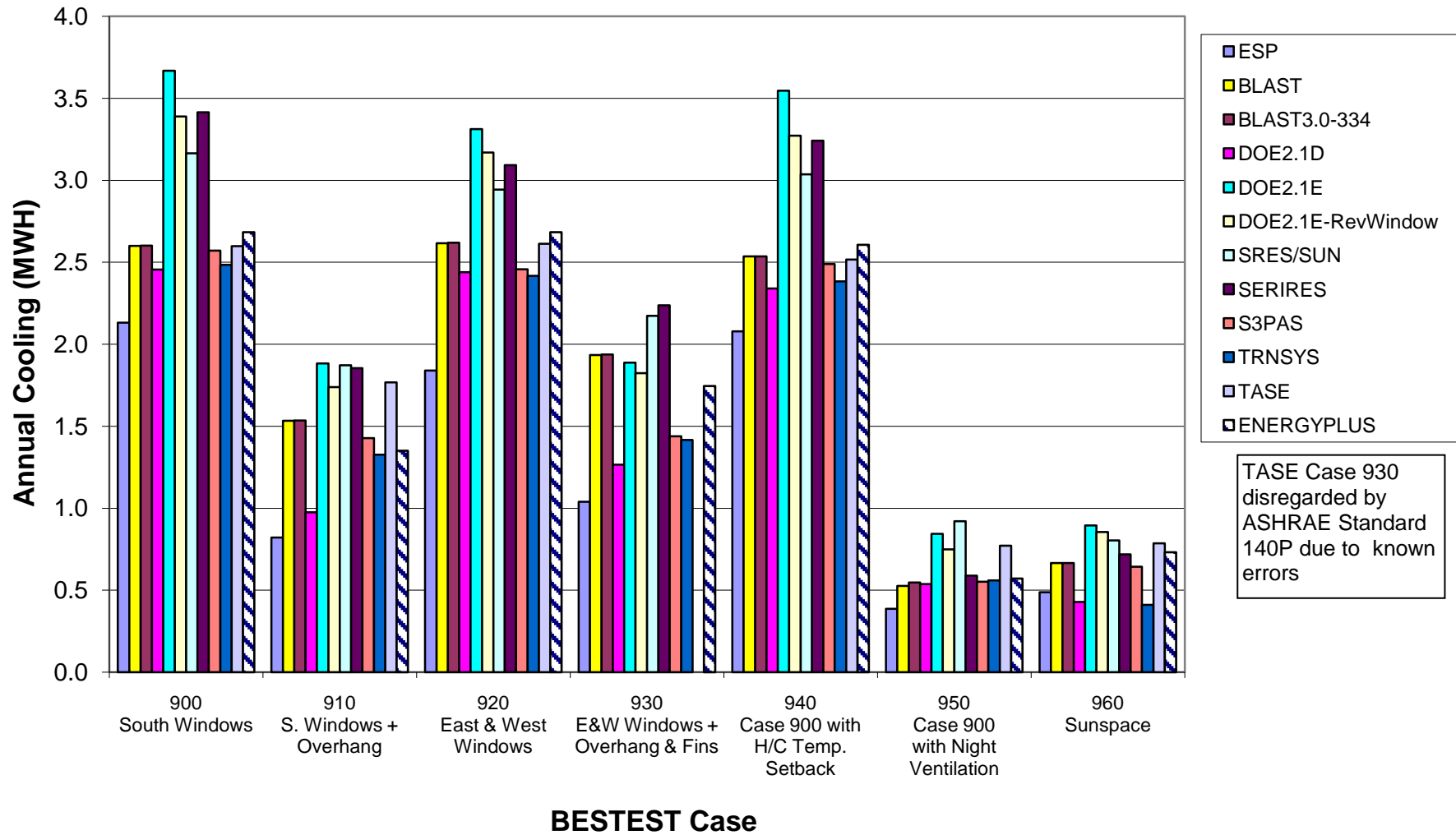

Standard 140-2007 Comparison High Mass Building Peak Heating

EnergyPlus Version 6.0.0.023

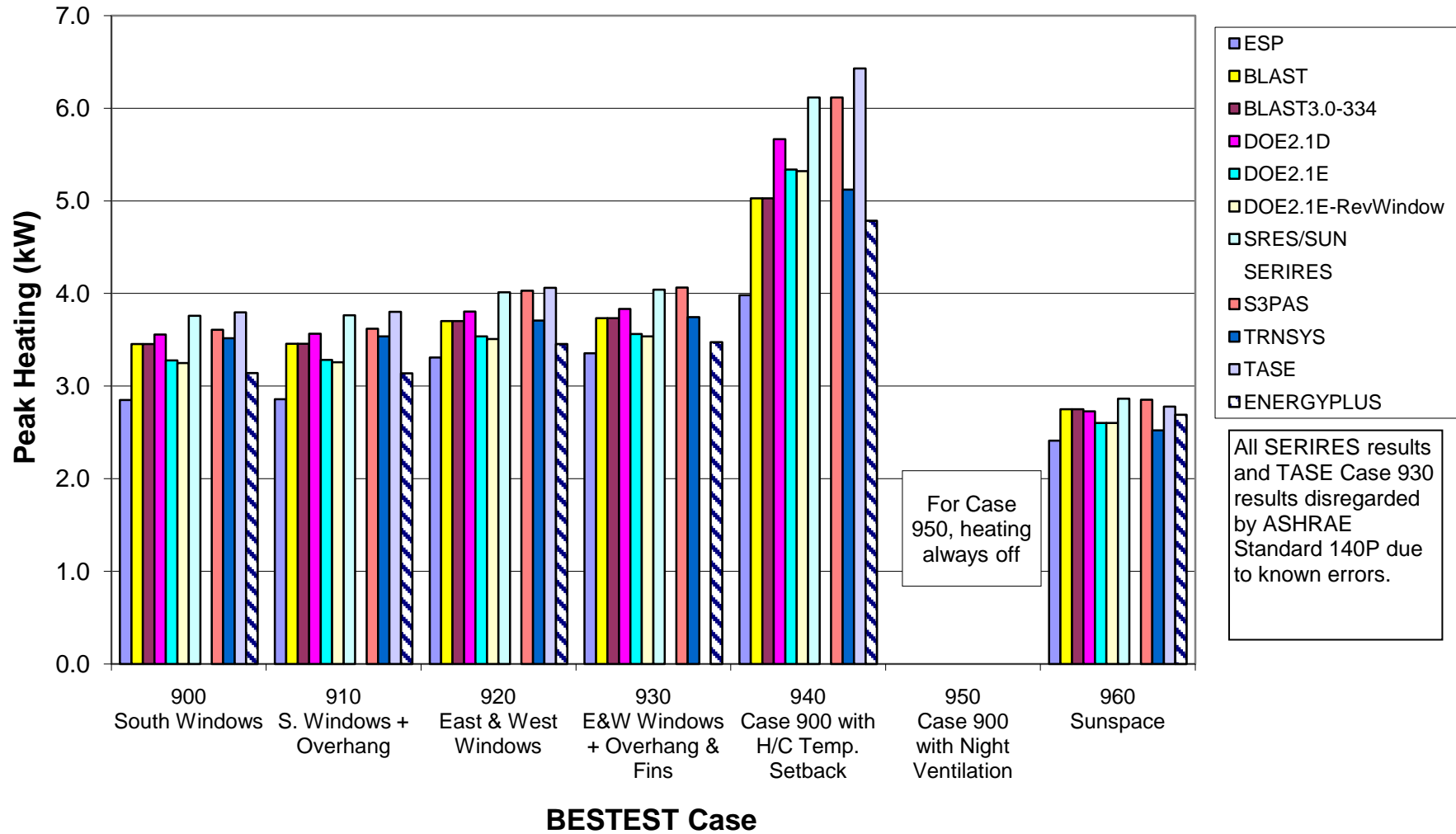

Standard 140-2007 Comparison High Mass Building Peak Cooling

EnergyPlus Version 6.0.0.023

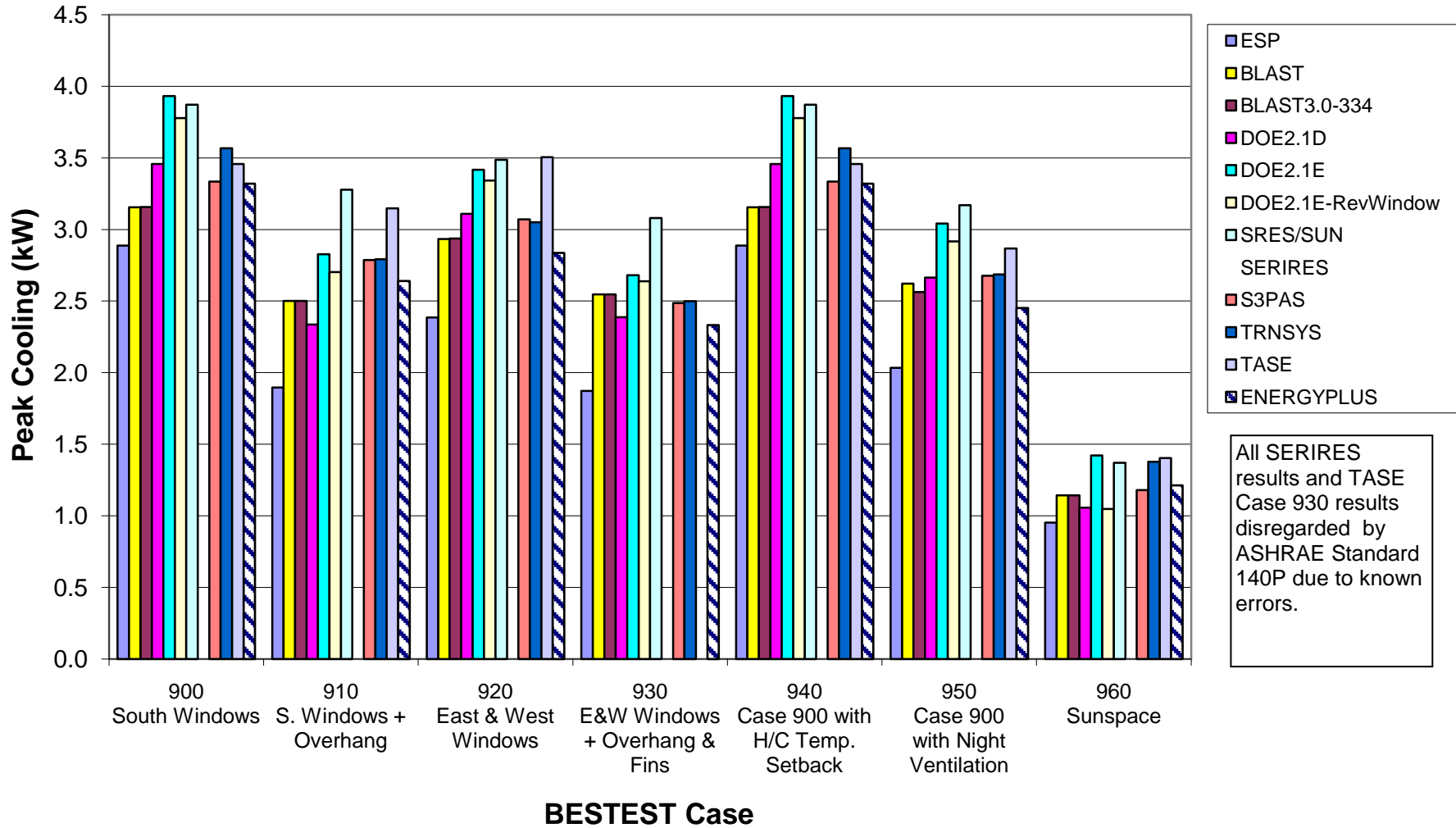

Standard 140-2007 Comparison

Free Floating Maximum Temperature

EnergyPlus Version 6.0.0.023

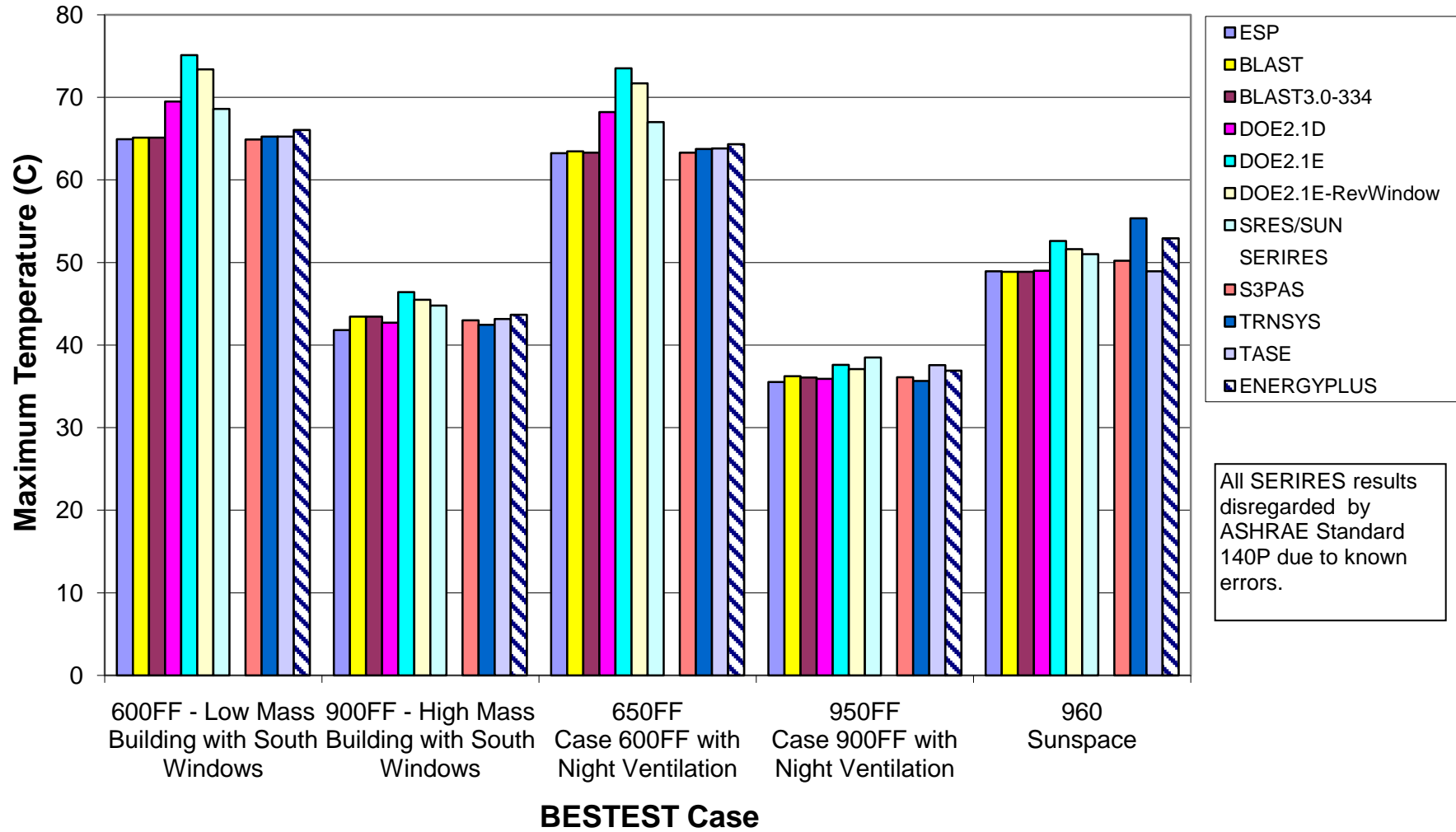

Standard 140-2007 Comparison

Free Floating Minimum Temperature

EnergyPlus Version 6.0.0.023

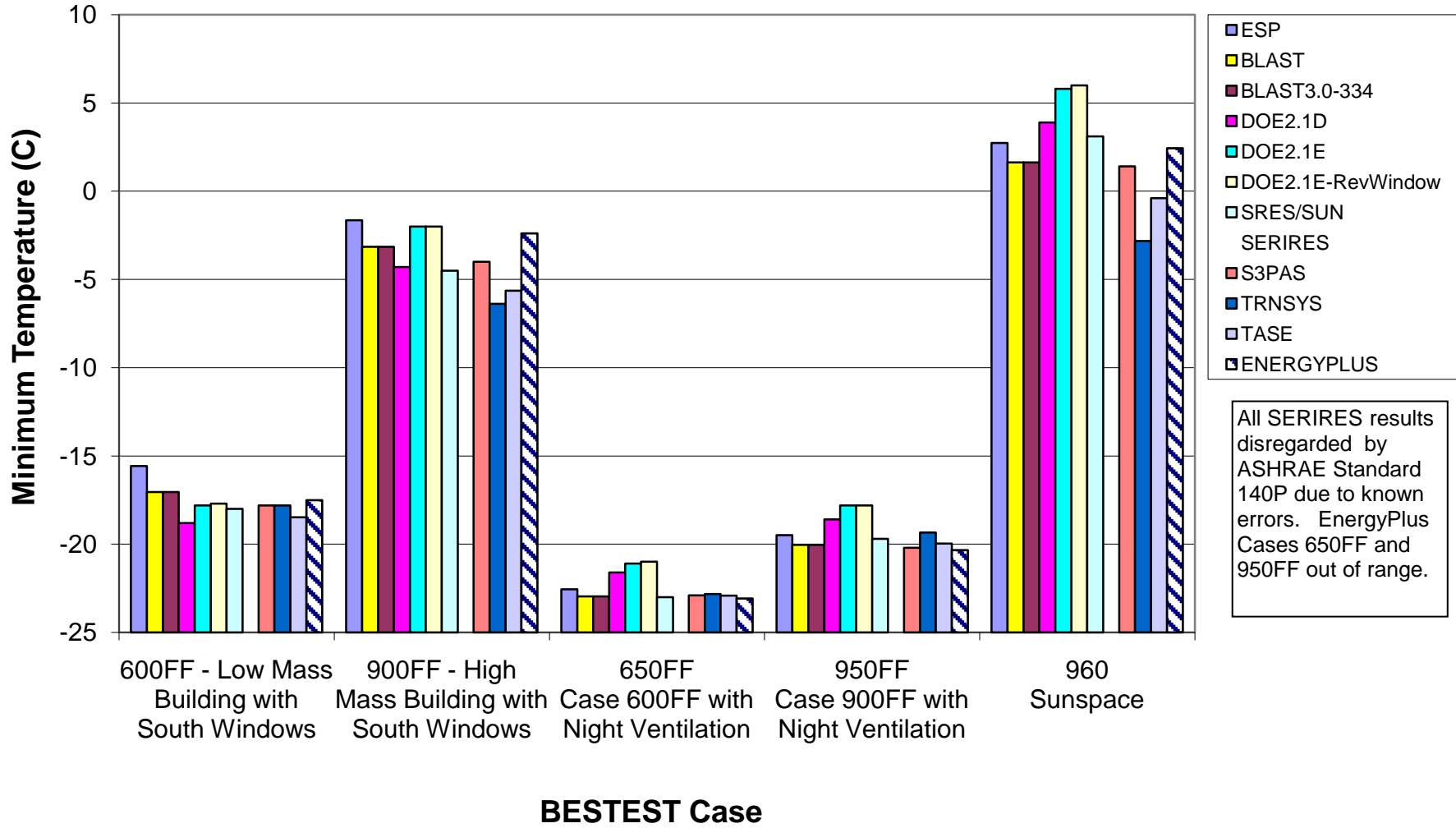

Standard 140-2007 Comparison

Low Mass Building (low absorptances, no windows)

EnergyPlus Version 6.0.0.023

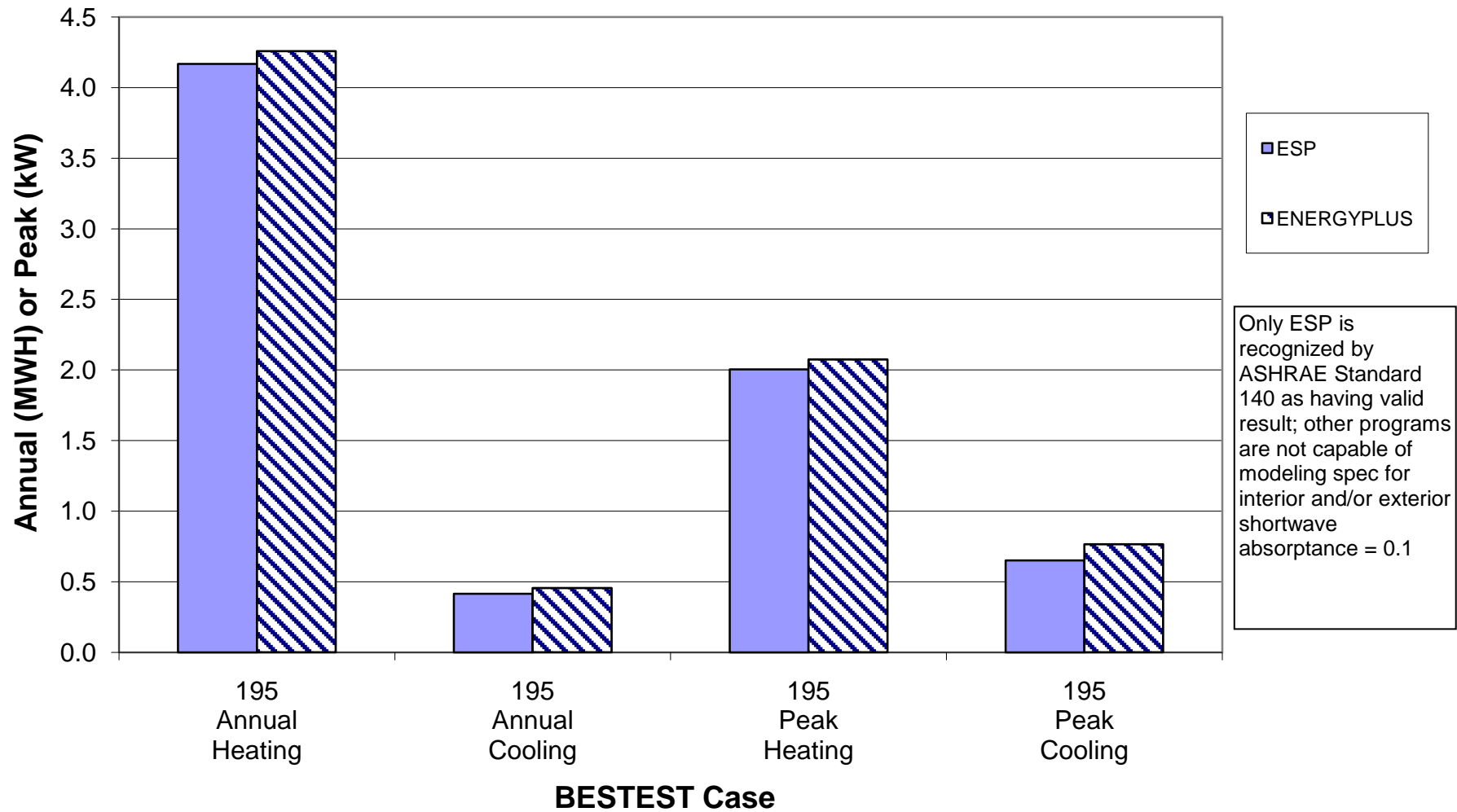

Appendix B

Tables Comparing EnergyPlus Results with Other Whole Building Energy Simulation Programs

Comparison Of EnergyPlus Results with Standard 140-2007

Using EnergyPlus Version 6.0.0.023 with Standard 140-2007 weather file

BESTEST Min, Max, Average values conform with ASHRAE Standard 140
and also include results for DOE-2.1E and BLAST 3.0-334

Low Mass Building

BESTEST Case **195**

Description **Solid Conduction Problem**
Rectangular box of low mass construction
No windows, internal load or infiltration
Constant 20C setpoint

Annual Heating (MWh)

BESTEST Minimum	4.1670
BESTEST Maximum	4.1670
BESTEST Average	4.1670
E-Plus	4.2573
Difference, %	2.2%
EnergyPlus Within Range	NO

Annual Cooling (MWh)

BESTEST Minimum	0.4140
BESTEST Maximum	0.4140
BESTEST Average	0.4140
E-Plus	0.4545
Difference, %	9.8%
EnergyPlus Within Range	NO

Peak Heating (KW)

BESTEST Minimum	2.0040
BESTEST Maximum	2.0040
BESTEST Average	2.0040
E-Plus	2.0733
Difference, %	3.5%
EnergyPlus Within Range	NO

Peak Cooling (KW)

BESTEST Minimum	0.651
BESTEST Maximum	0.651
BESTEST Average	0.651
E-Plus	0.7650
Difference, %	17.5%
EnergyPlus Within Range	NO

Comparison Of EnergyPlus Results with BESTEST
Using EnergyPlus Version 6.0.0.023 with Standard 140-2007 weather file

BESTEST Min, Max, Average values conform with ASHRAE Standard 140
and also include results for DOE-2.1E and BLAST 3.0-334

Low Mass Building

BESTEST Case	600	610	620	630	640	650
Description	Basic Heat Transfer Problem Windows on South wall 200 w internal load 0.5 ACH infiltration H/C Setpoint 20C/27C	South Shade Problem Same as 600 with 1.0M overhang on South Wall	East/West Incid./Trans. Problem Windows on East & West wall 200 w internal load 0.5 ACH infiltration H/C Setpoint 20C/27C	East/West Shade Problem Same as 620 with 1.0M overhang & fins on windows from roof to ground	Setback Problem Same as 600 Setback Thermostat Cooling 27C, all hours Heating 10C, 2300 to 0700 Heating 20C, 0700 to 2300	Night Ventilation Problem Same as 600 Vent air 1800-700 hrs Cooling 27C, 700-1800 hrs Heating, always off
Annual Heating (MWh)						
BESTEST Minimum	4.296	4.355	4.613	5.050	2.751	0
BESTEST Maximum	5.709	5.786	5.944	6.469	3.803	0.000
BESTEST Average	5.046	5.098	5.328	5.686	3.135	0.000
E-Plus	4.364	4.398	4.512	4.813	2.667	0.000
Difference, %	-13.5%	-13.7%	-15.3%	-15.3%	-14.9%	-100.0%
EnergyPlus Within Range	YES	YES	NO	NO	NO	YES
Annual Cooling (MWh)						
BESTEST Minimum	6.137	3.915	3.417	2.129	5.952	4.816
BESTEST Maximum	8.448	6.139	5.482	3.701	8.097	7.064
BESTEST Average	7.053	5.144	4.416	2.951	6.790	5.708
E-Plus	7.006	4.976	4.384	2.952	6.710	5.538
Difference, %	-0.7%	-3.3%	-0.7%	0.0%	-1.2%	-3.0%
EnergyPlus Within Range	YES	YES	YES	YES	YES	YES
Peak Heating (KW)						
BESTEST Minimum	3.437	3.437	3.591	3.592	5.232	0
BESTEST Maximum	4.354	4.354	4.379	4.28	6.954	0
BESTEST Average	3.952	3.947	3.998	3.949	5.903	0.000
E-Plus	3.732	3.720	3.726	3.703	6.265	0.000
Difference, %	-5.5%	-5.8%	-6.8%	-6.2%	6.1%	#DIV/0!
EnergyPlus Within Range	YES	YES	YES	YES	YES	YES
Peak Cooling (KW)						
BESTEST Minimum	5.965	5.669	3.634	3.072	5.884	5.831
BESTEST Maximum	7.188	6.673	5.096	4.116	7.126	7.068
BESTEST Average	6.535	6.090	4.393	3.688	6.478	6.404
E-Plus	6.678	6.274	4.005	3.446	6.614	6.479
Difference, %	2.2%	3.0%	-8.8%	-6.6%	2.1%	1.2%
EnergyPlus Within Range	YES	YES	YES	YES	YES	YES

Comparison Of EnergyPlus Results with BESTEST

Using EnergyPlus Version 6.0.0.023 with Standard 140-2007 weather file

BESTEST Min, Max, Average values conform with ASHRAE Standard 140 and also include results for DOE-2.1E and BLAST 3.0-334

Free Floating Zone Temperature

BESTEST Case	600FF	900FF	650FF	950FF	960
Description	Basic Heat Transfer Problem Low Mass Building Windows on South wall 200 w internal load 0.5 ACH infiltration Free Float Temperature	Basic Heat Transfer Problem High Mass Building Windows on South wall 200 w internal load 0.5 ACH infiltration Free Float Temperature	Basic Heat Transfer Problem Low Mass Building Windows on South wall 200 w internal load 0.5 ACH infiltration Vent Air 1703.16 m3/h 1800-700 h Free Float Temperature	Basic Heat Transfer Problem High Mass Building Windows on South wall 200 w internal load 0.5 ACH infiltration Vent Air 1703.16 m3/h 1800-700 h Free Float Temperature	Passive Solar Problem Same as 900 but with sunspace and interior wall Sunspace is uncontrolled and has two windows
Maximum Annual Hourly Zone Temperature (C)					
BESTEST Minimum	64.9	41.8	63.2	35.5	48.9
BESTEST Maximum	75.1	46.4	73.5	38.5	55.34
BESTEST Average	67.7	43.7	66.1	36.6	50.5
E-Plus	66.0	43.7	64.3	36.9	52.9
Difference, %	-2.5%	-0.1%	-2.7%	0.8%	4.7%
EnergyPlus Within Range	YES	YES	YES	YES	YES
Minimum Annual Hourly Zone Temperature (C)					
BESTEST Minimum	-18.8	-6.4	-23.0	-20.2	-2.8
BESTEST Maximum	-15.6	-1.6	-21.0	-17.8	6.0
BESTEST Average	-17.6	-3.7	-22.4	-19.3	2.3
E-Plus	-17.5	-2.4	-23.1	-20.3	2.4
Difference, %	-0.5%	-35.1%	3.1%	5.4%	6.0%
EnergyPlus Within Range	YES	YES	NO	NO	YES
Average Annual Hourly Zone Temperature (C)					
BESTEST Minimum	24.2	24.5	18.0	14.0	26.4
BESTEST Maximum	27.4	27.5	20.8	15.3	30.5
BESTEST Average	25.3	25.5	18.9	14.5	28.2
E-Plus	26.2	26.4	18.9	14.6	29.5
Difference, %	3.4%	3.6%	-0.2%	1.0%	4.6%
EnergyPlus Within Range	YES	YES	YES	YES	YES

Appendix C

Delta Charts Comparing EnergyPlus Results with Other Whole Building Energy Simulation Programs

Standard 140-2007 Comparison South Shaded Window (Delta) Annual Heating and Cooling

EnergyPlus Version 6.0.0.023

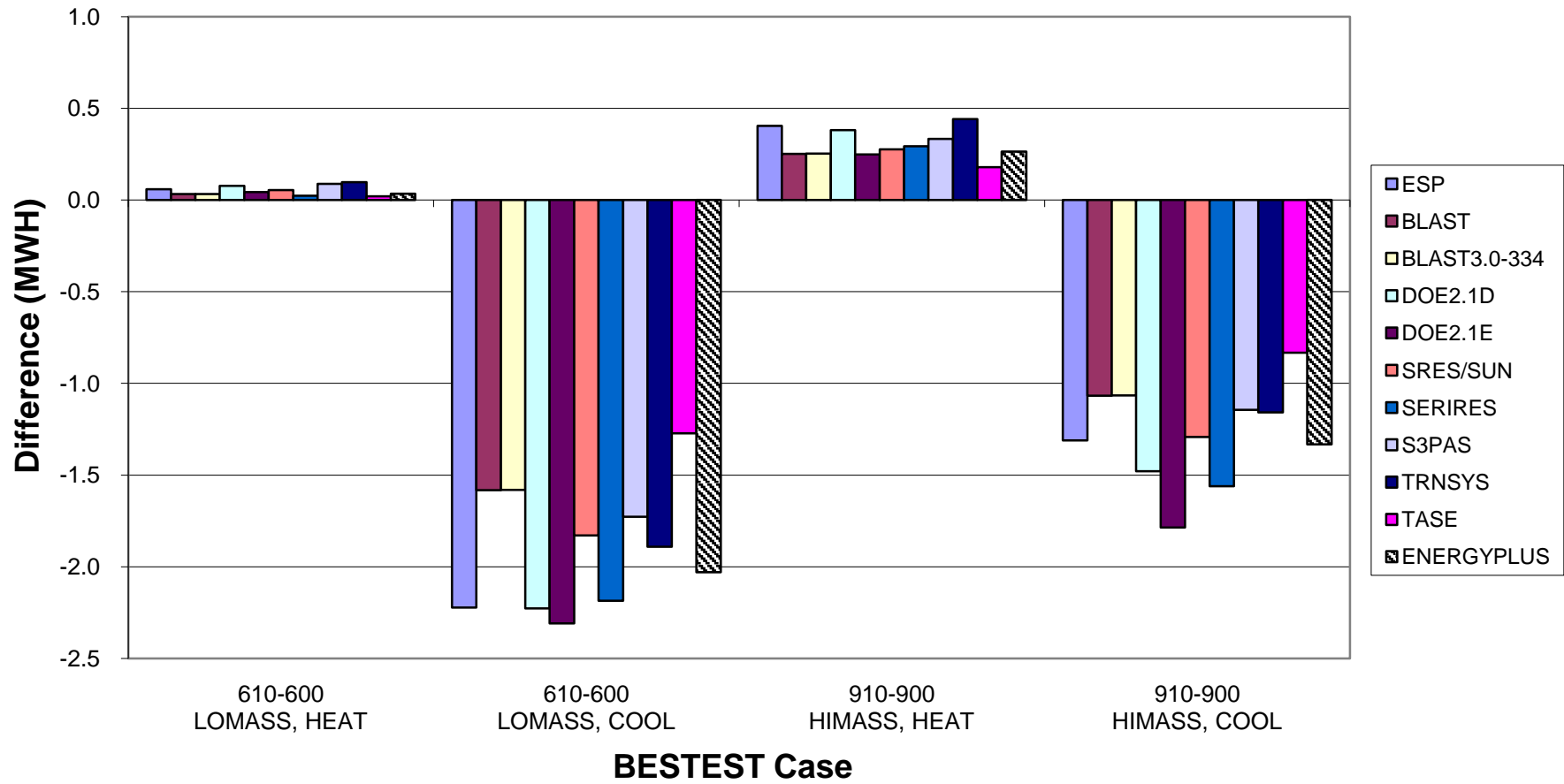

Standard 140-2007 Comparison South Shaded Window (Delta) Peak Heating and Cooling EnergyPlus Version 6.0.0.023

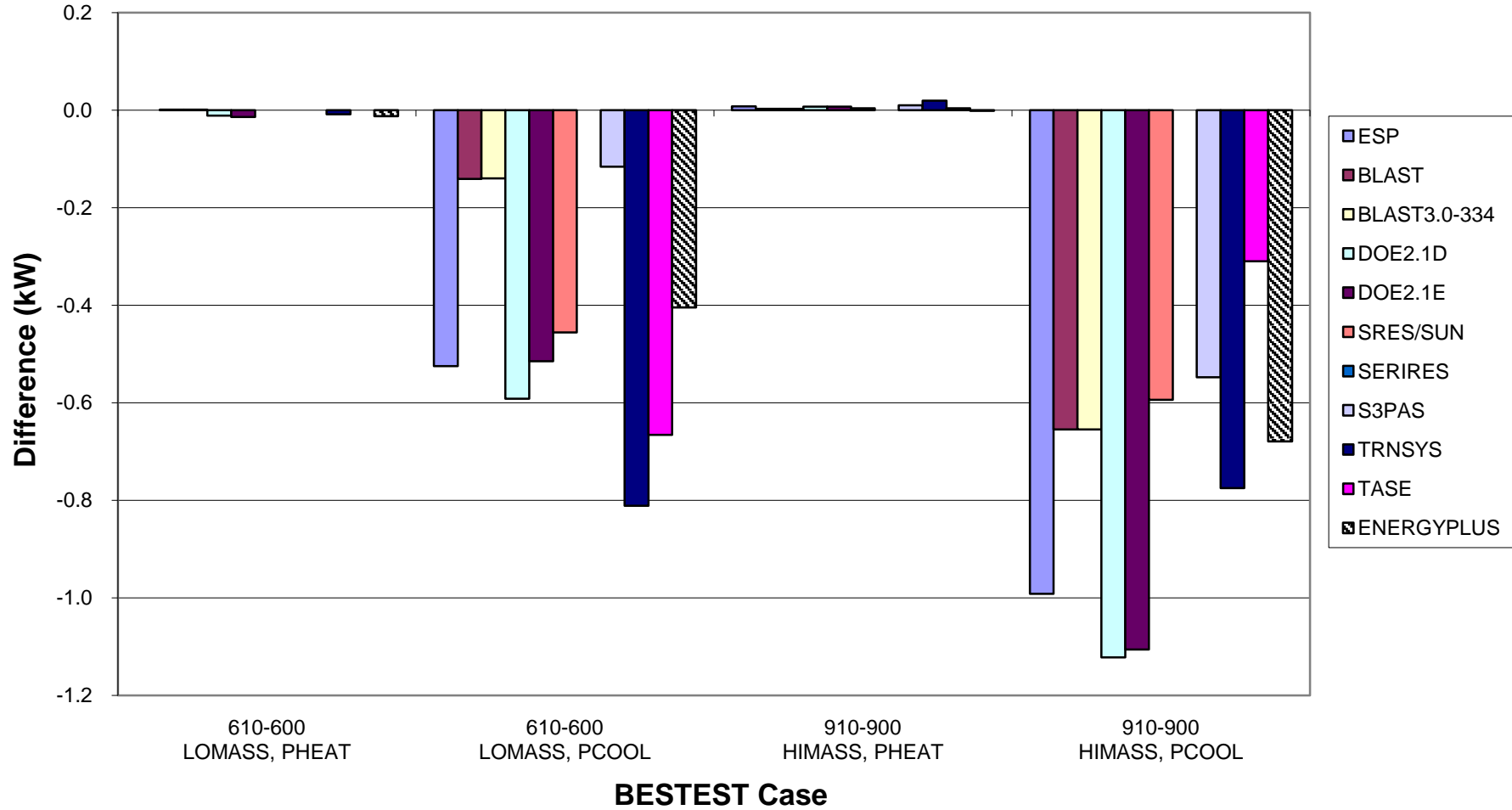

Standard 140-2007 Comparison East & West Window (Delta) Annual Heating and Cooling EnergyPlus Version 6.0.0.023

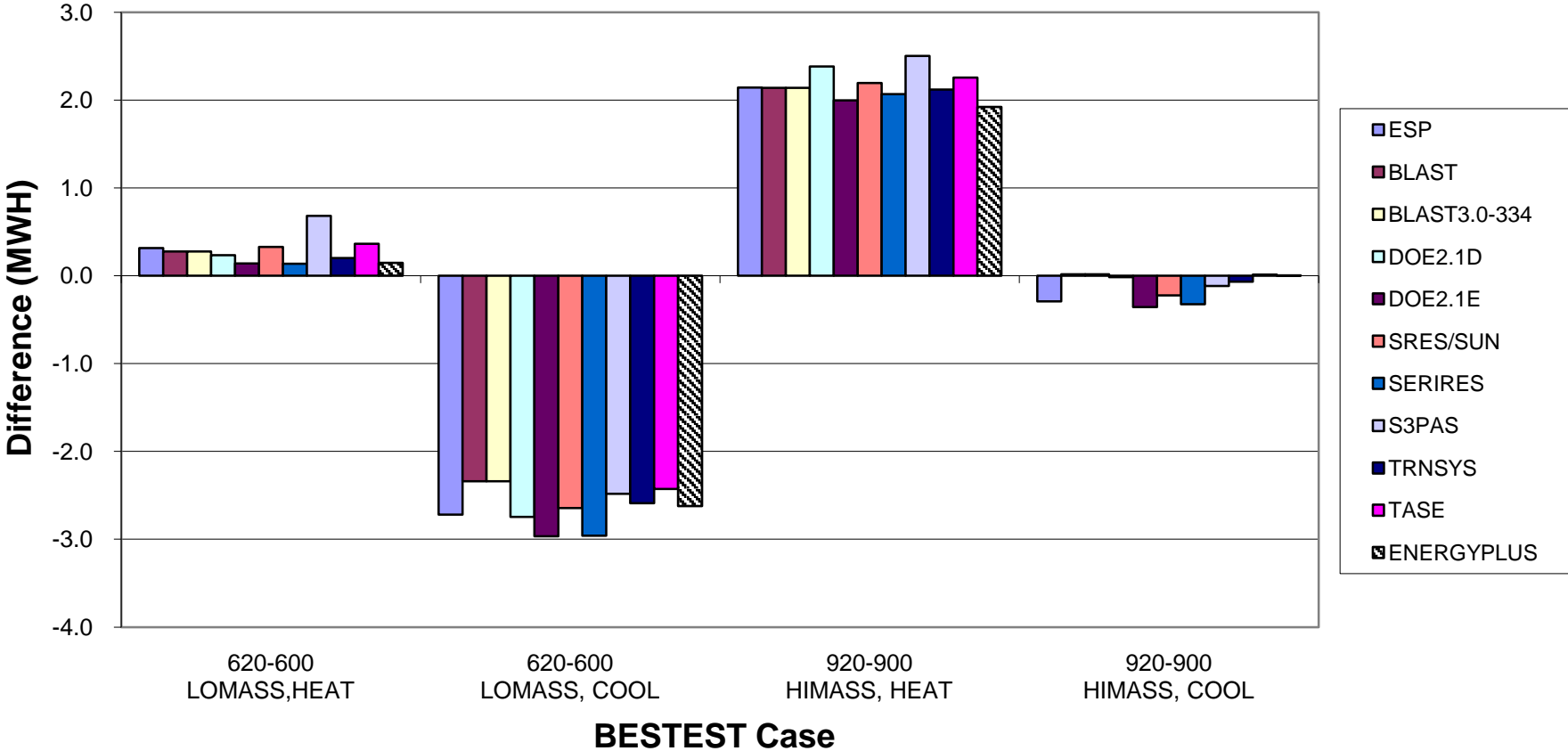

BStandard 140-2007 Comparison East & West Window (Delta) Peak Heating and Cooling EnergyPlus Version 6.0.0.023

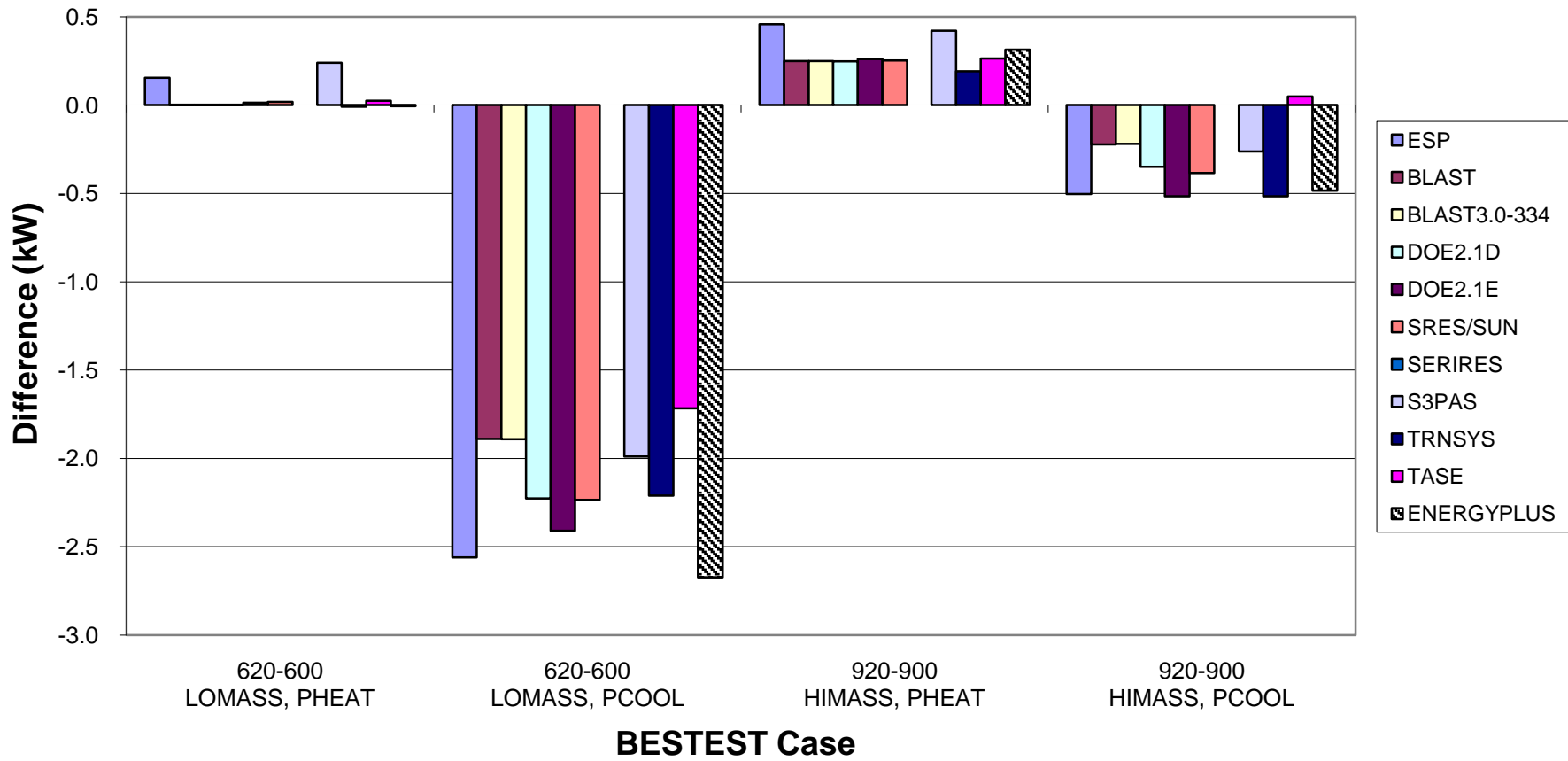

Standard 140-2007 Comparison East & West Shaded Window (Delta) Annual Heating and Cooling

EnergyPlus Version 6.0.0.023

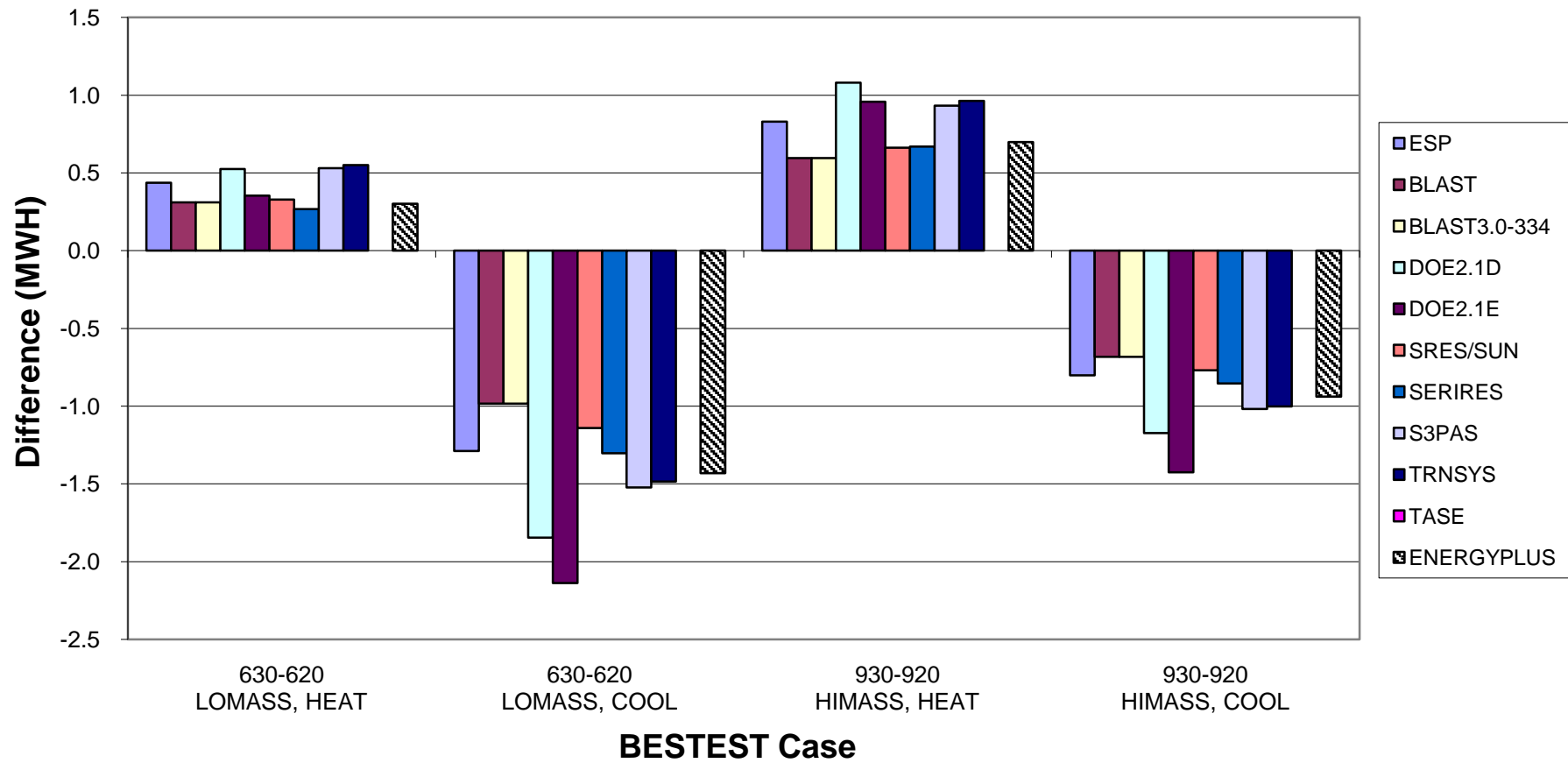

Standard 140-2007 Comparison East & West Shaded Window (Delta) Peak Heating and Cooling

EnergyPlus Version 6.0.0.023

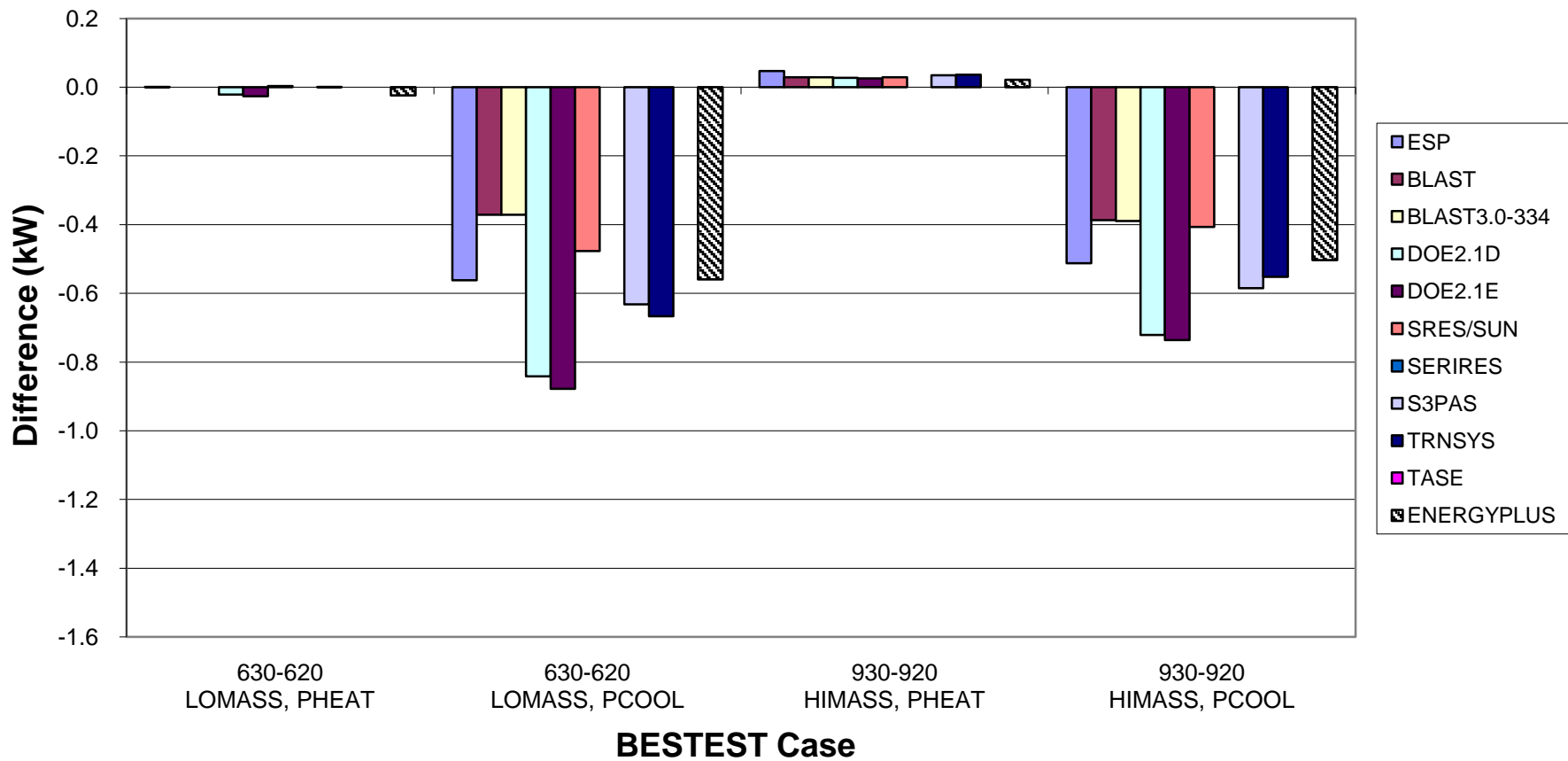

Standard 140-2007 Comparison Thermostat Setback (Delta) Annual Heating EnergyPlus Version 6.0.0.023

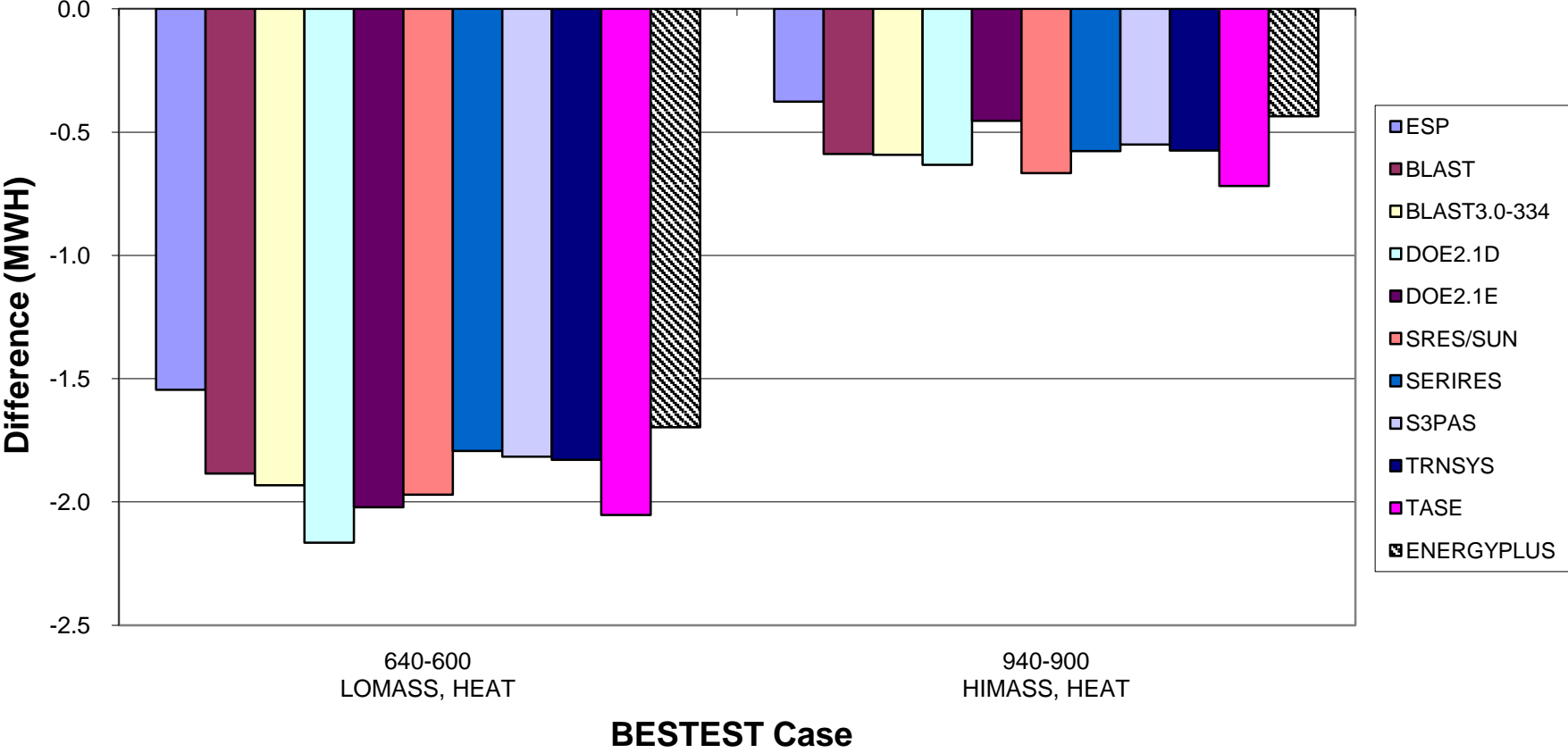

**Standard 140-2007 Comparison
Thermostat Setback (Delta)
Peak Heating
EnergyPlus Version 6.0.0.023**

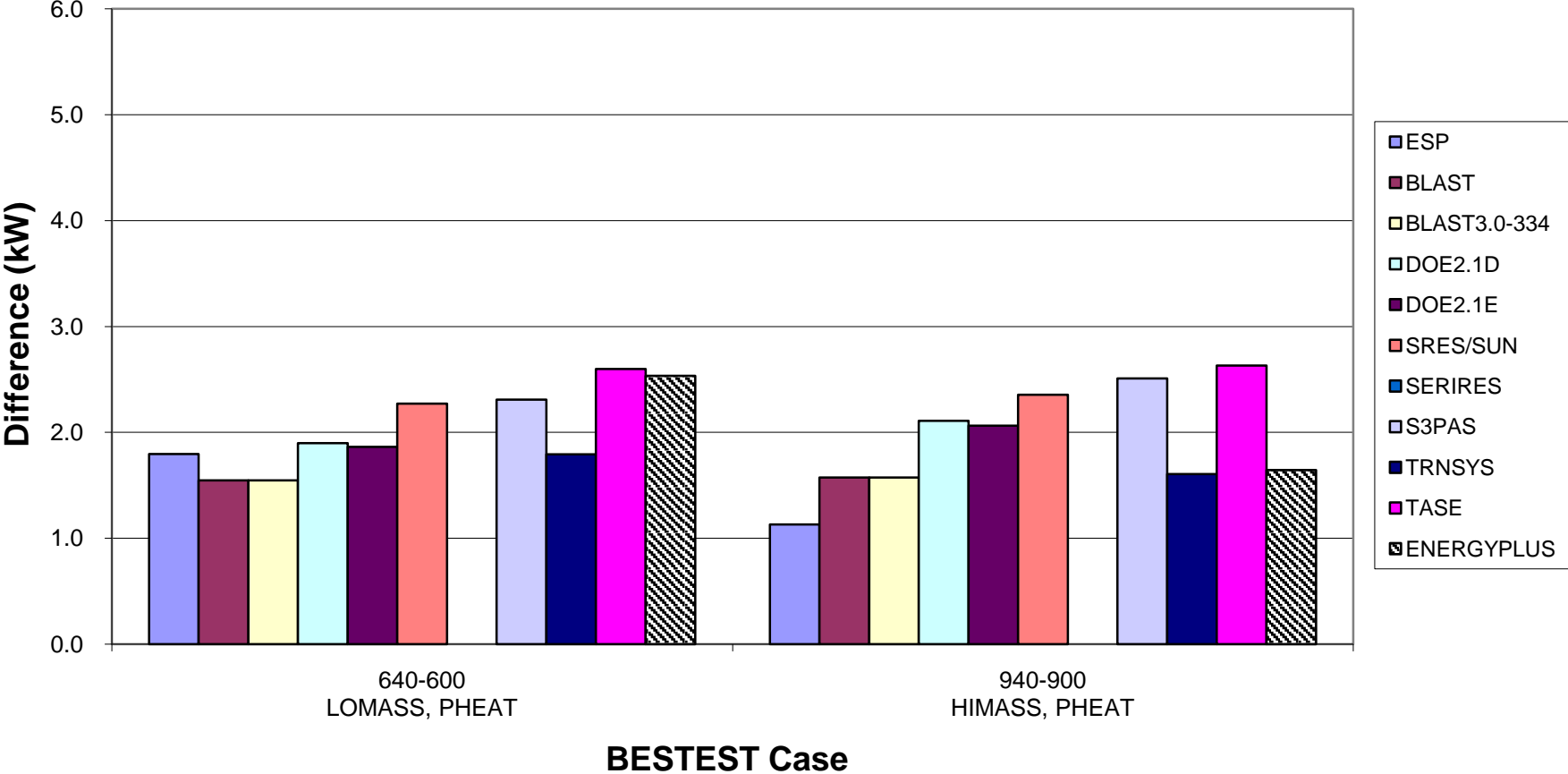

Standard 140-2007 Comparison Vent Cooling (Delta) Annual Cooling EnergyPlus Version 6.0.0.023

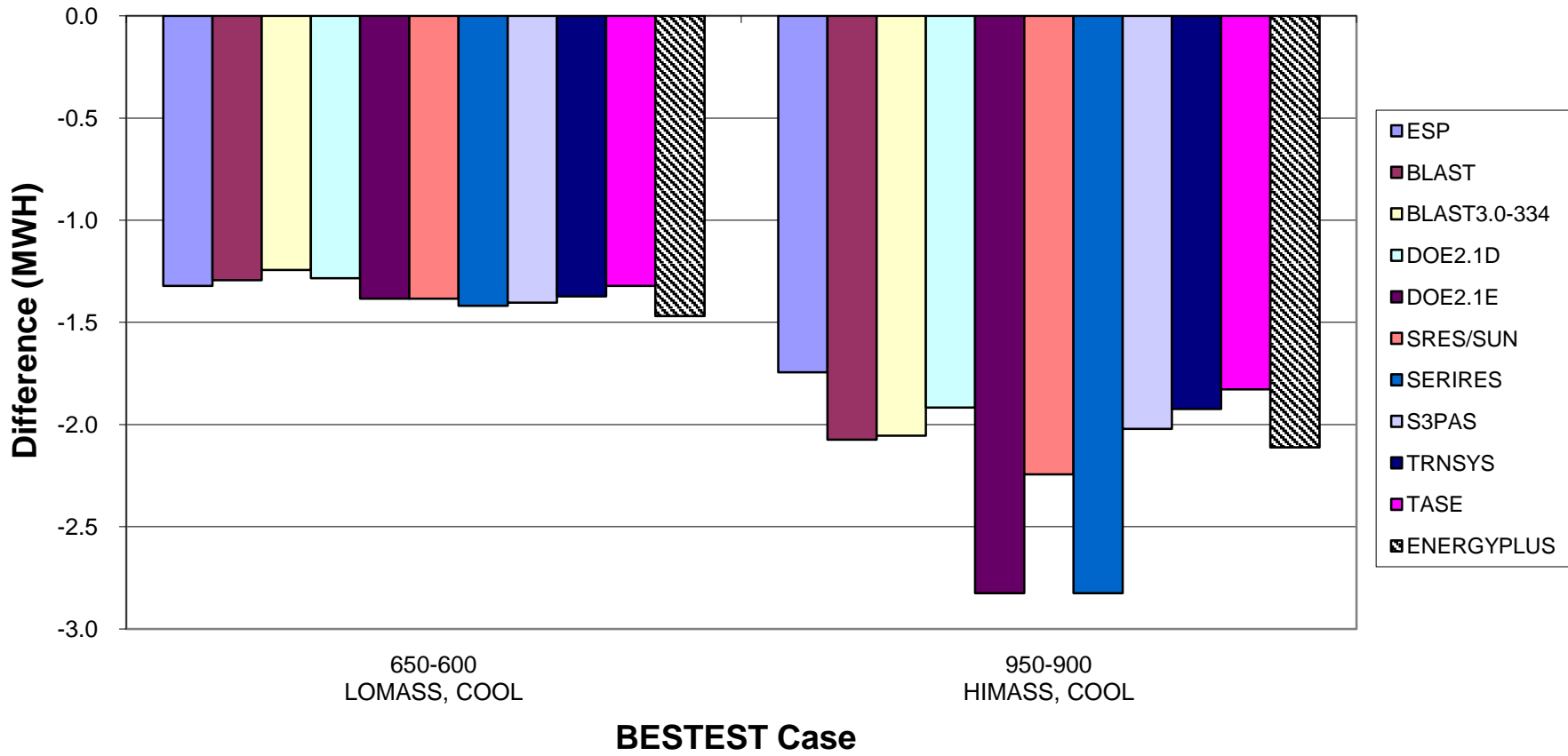

Standard 140-2007 Comparison Vent Cooling (Delta) Peak Cooling EnergyPlus Version 6.0.0.023

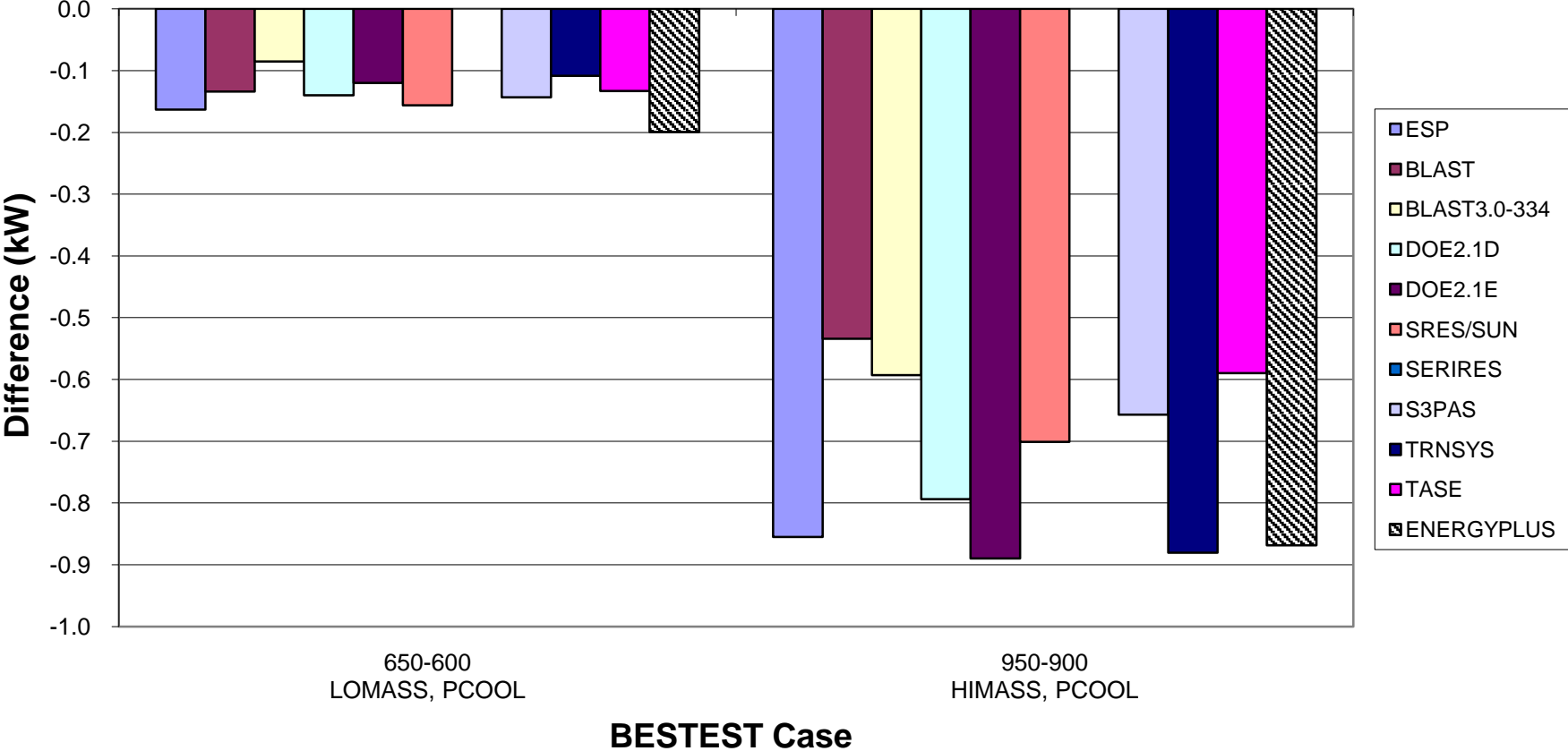

Standard 140-2007 Comparison Sunspace (Delta) Annual Heating and Cooling EnergyPlus Version 6.0.0.023

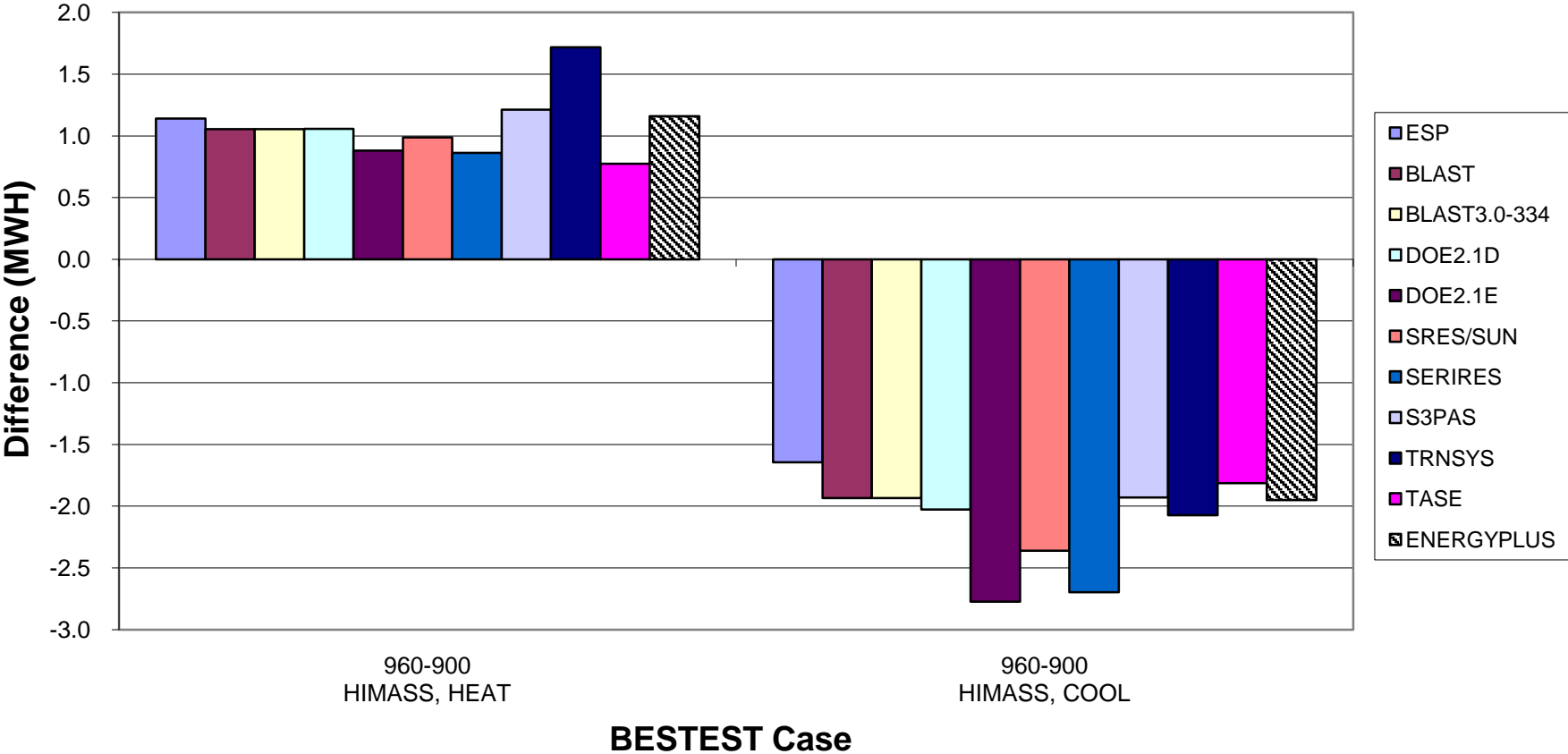

Standard 140-2007 Comparison Sunspace (Delta) Peak Heating and Cooling EnergyPlus Version 6.0.0.023

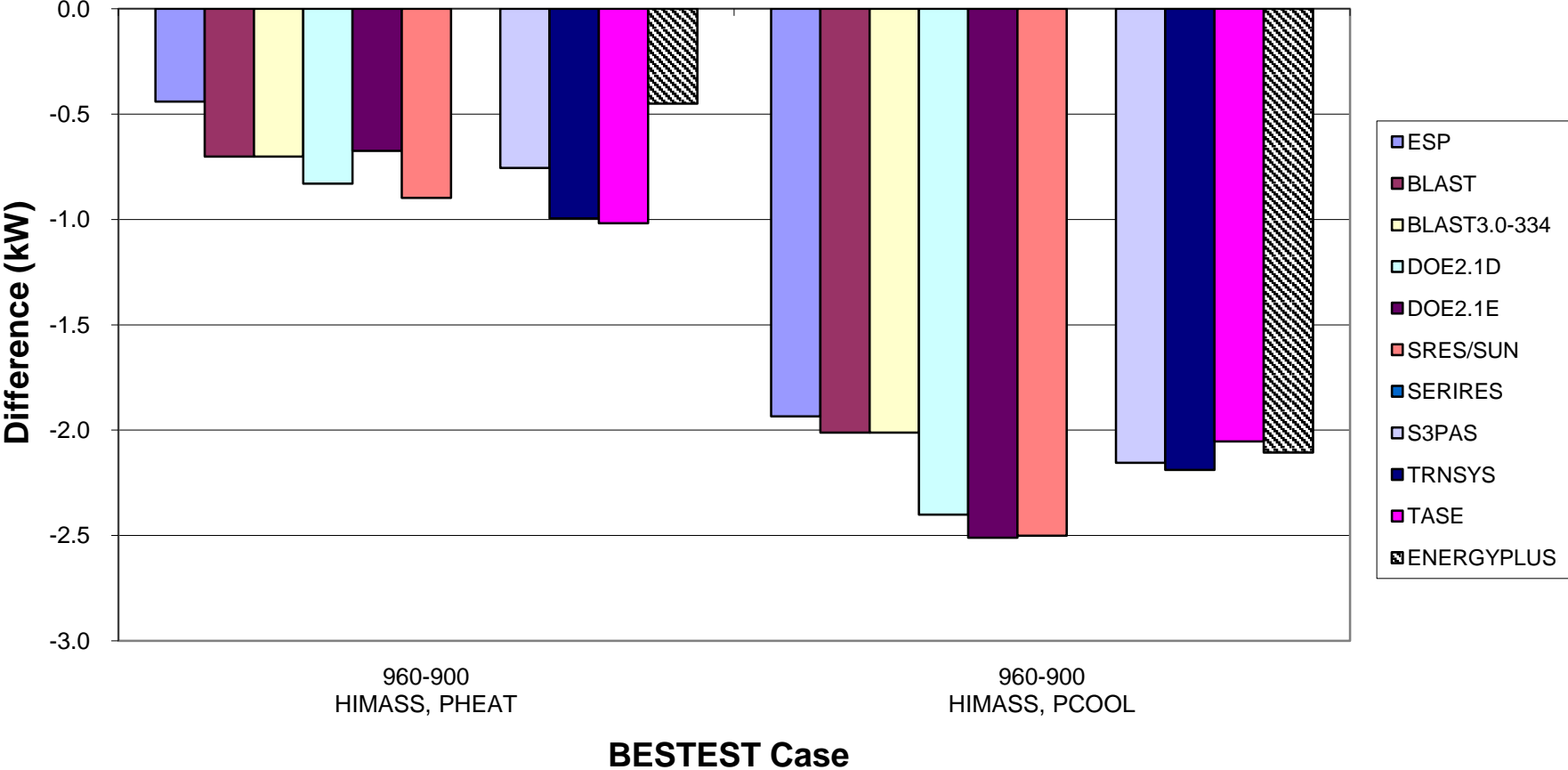

Appendix D

Additional BASIC and IN-DEPTH Test Charts Comparing EnergyPlus Results with Other Whole Building Energy Simulation Programs

BESTEST BASIC
Annual Transmitted SOLRAD Unshaded
(Diffuse + Direct)
EnergyPlus Version 6.0.0.023

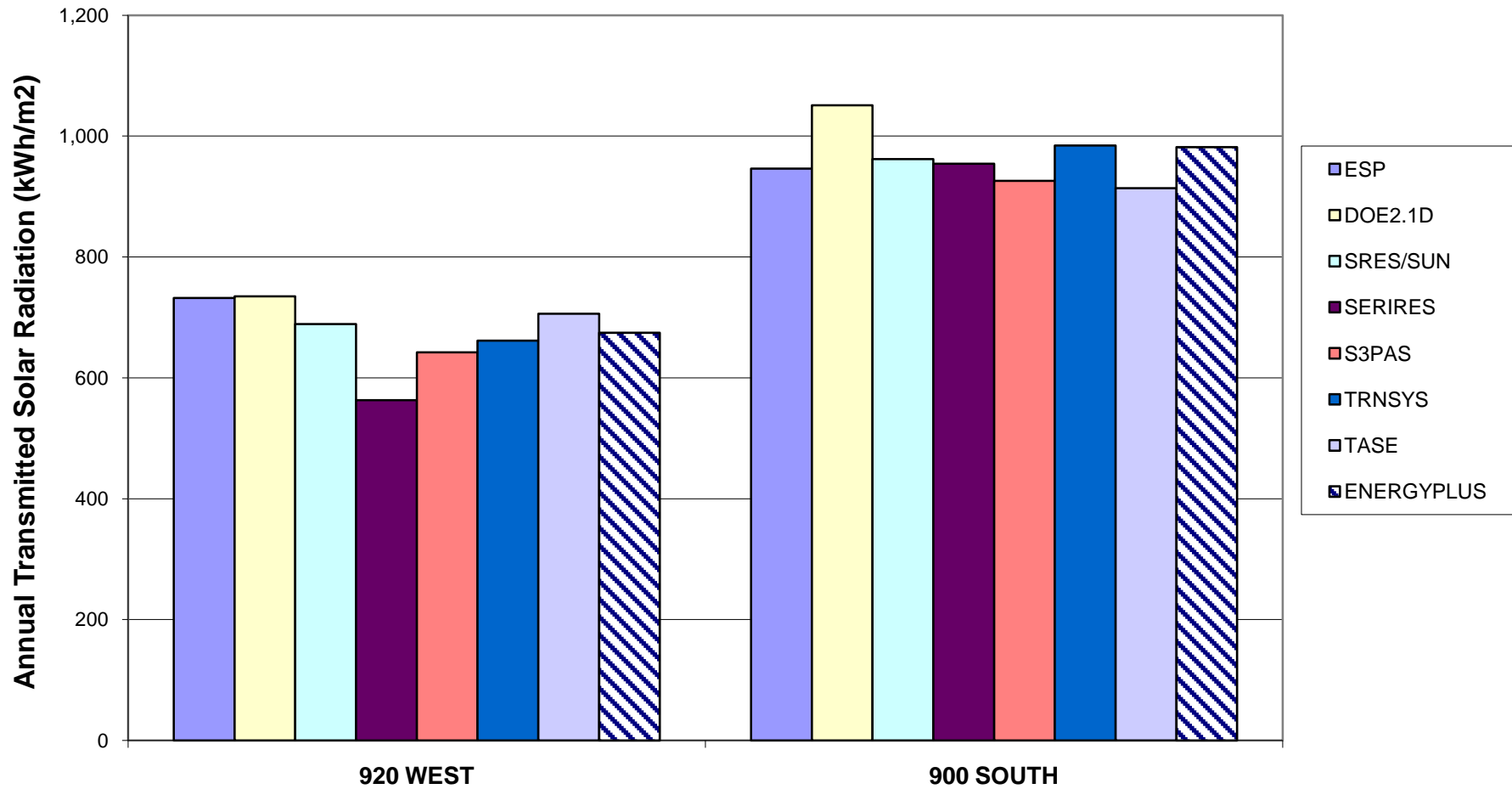

BESTEST BASIC

Annual Transmitted SOLRAD Shaded (Diffuse + Direct)

EnergyPlus Version 6.0.0.023

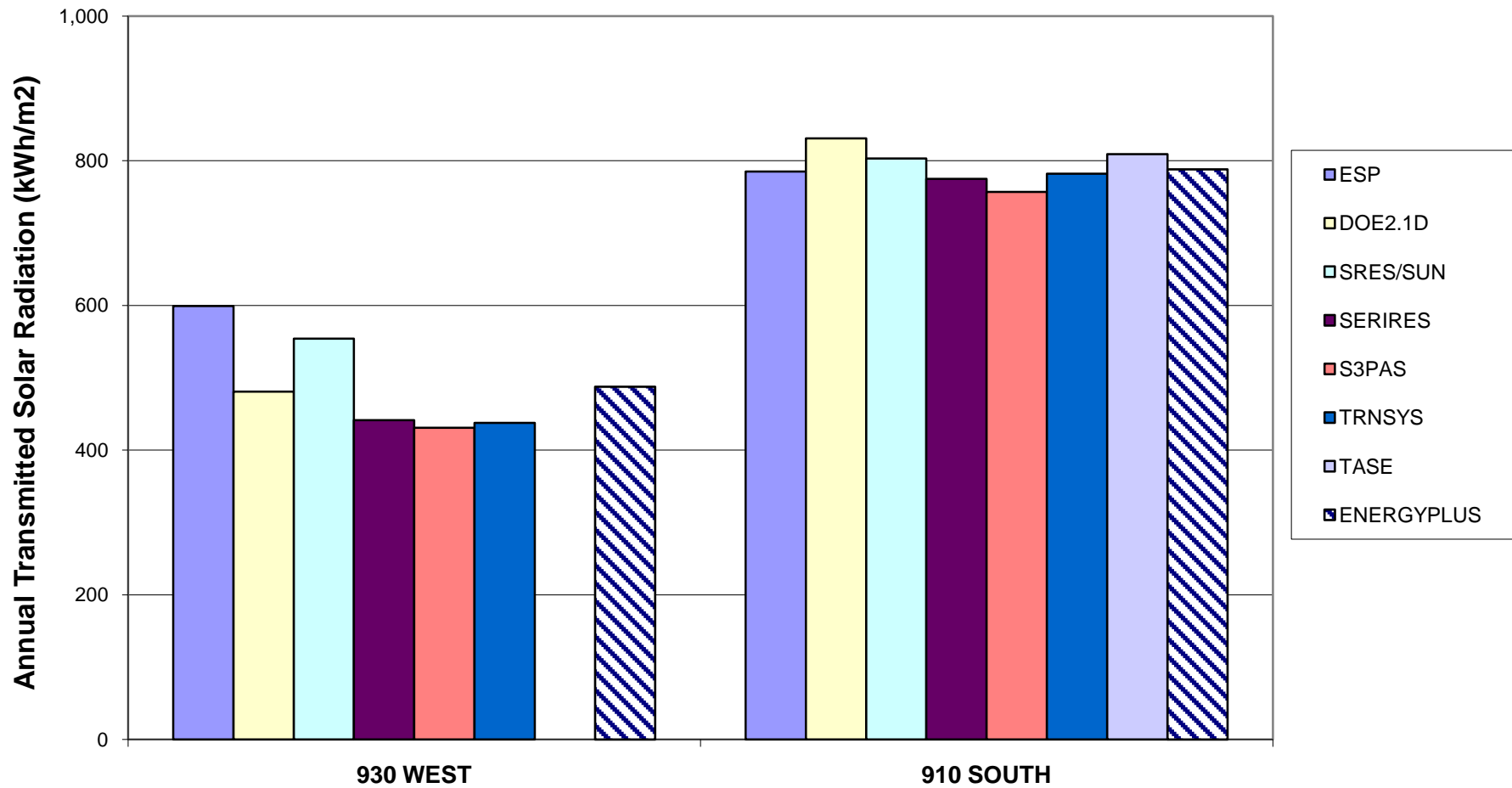

BESTEST BASIC
Annual Transmissivity Coefficient of Windows
(Unshaded Transmitted)/(Incident SOLRAD)
EnergyPlus Version 6.0.0.023

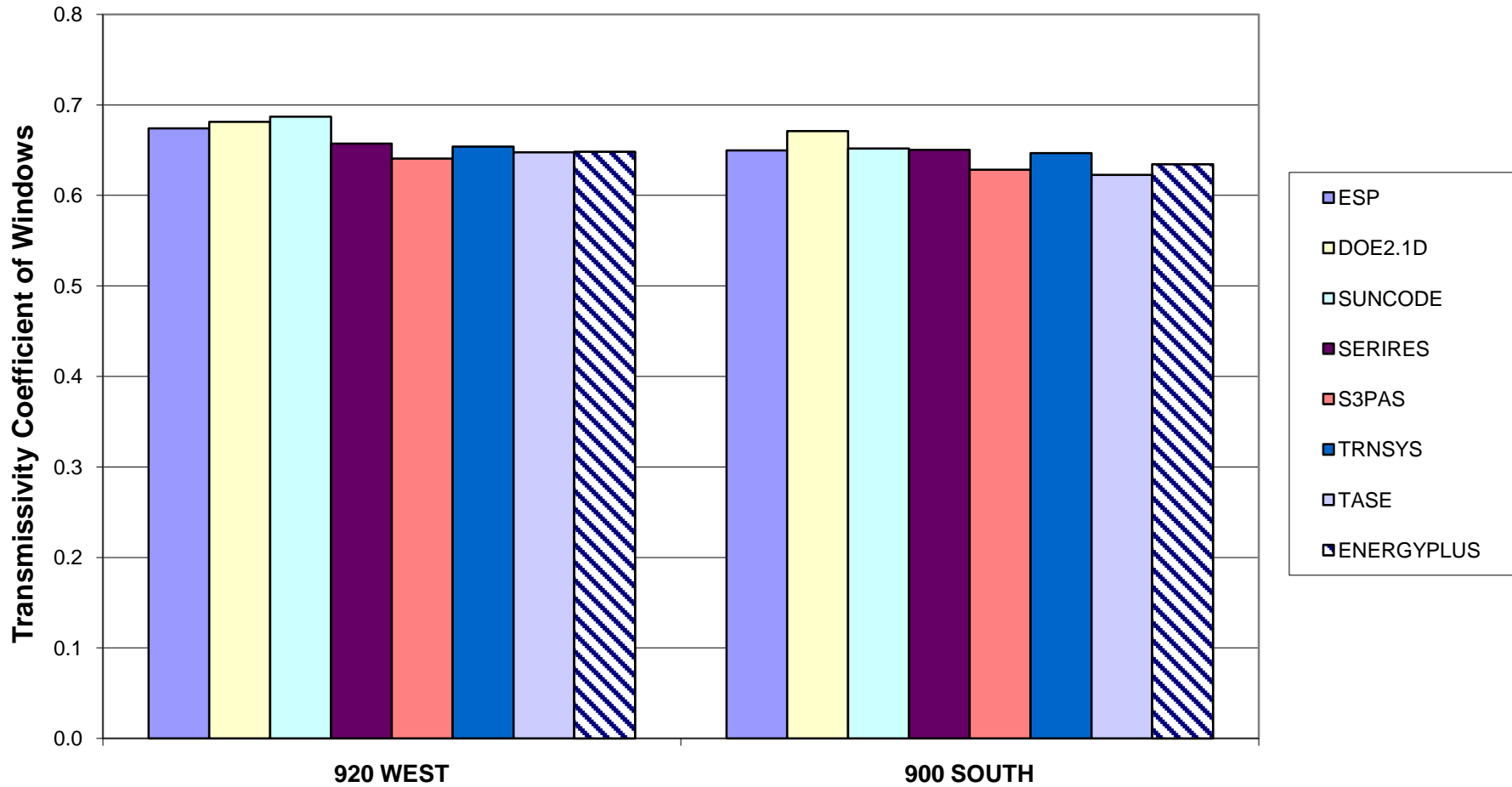

BESTEST BASIC

Annual Overhang and Fin Shading Coefficients (1-(Shaded)/(Unshaded)) Transmitted SOLRAD

EnergyPlus Version 6.0.0.023

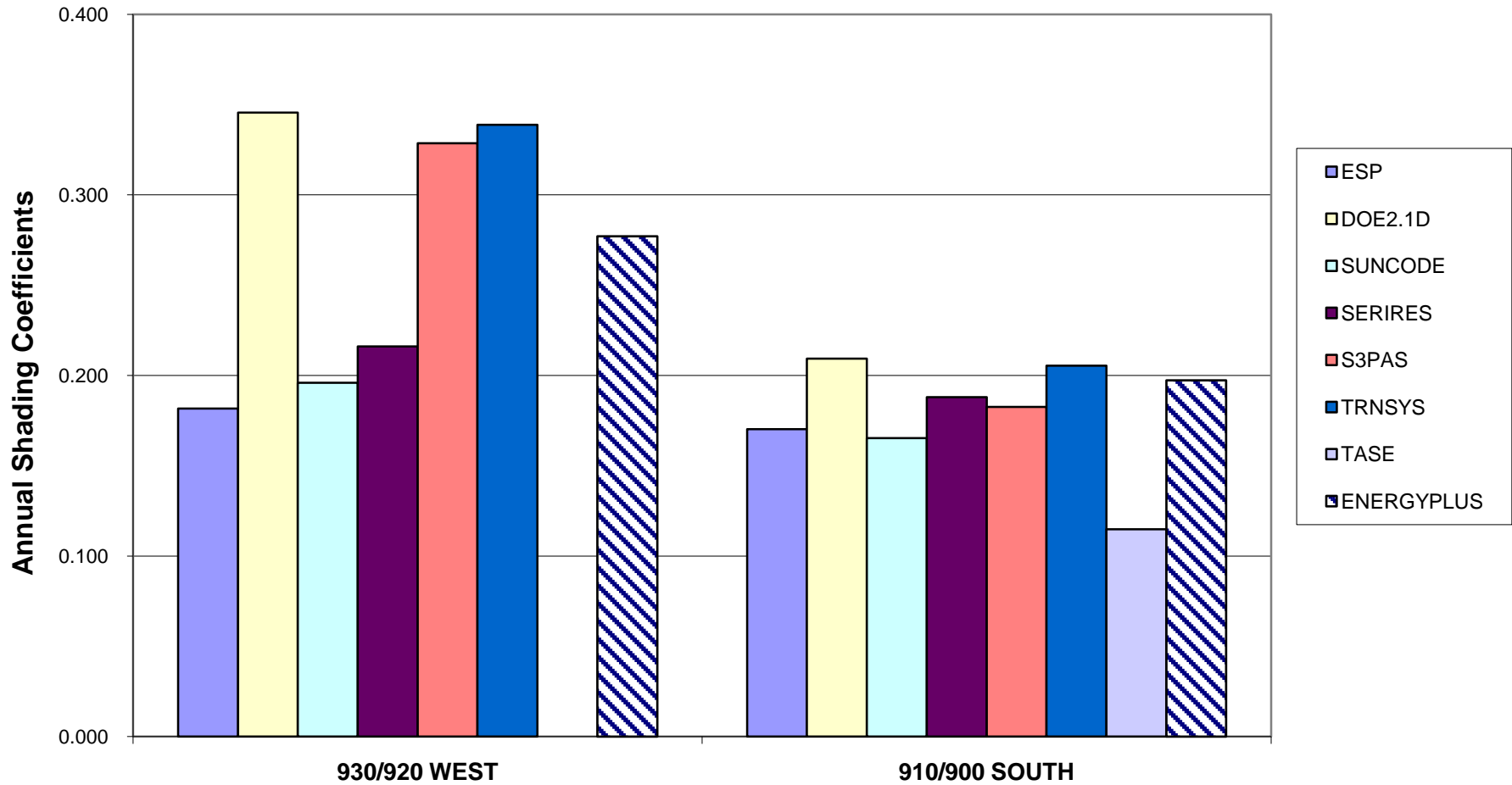

Standard 140-2007 In-Depth Comparison Low Mass Annual Heating Cases 195 to 250 EnergyPlus Version 6.0.0.023

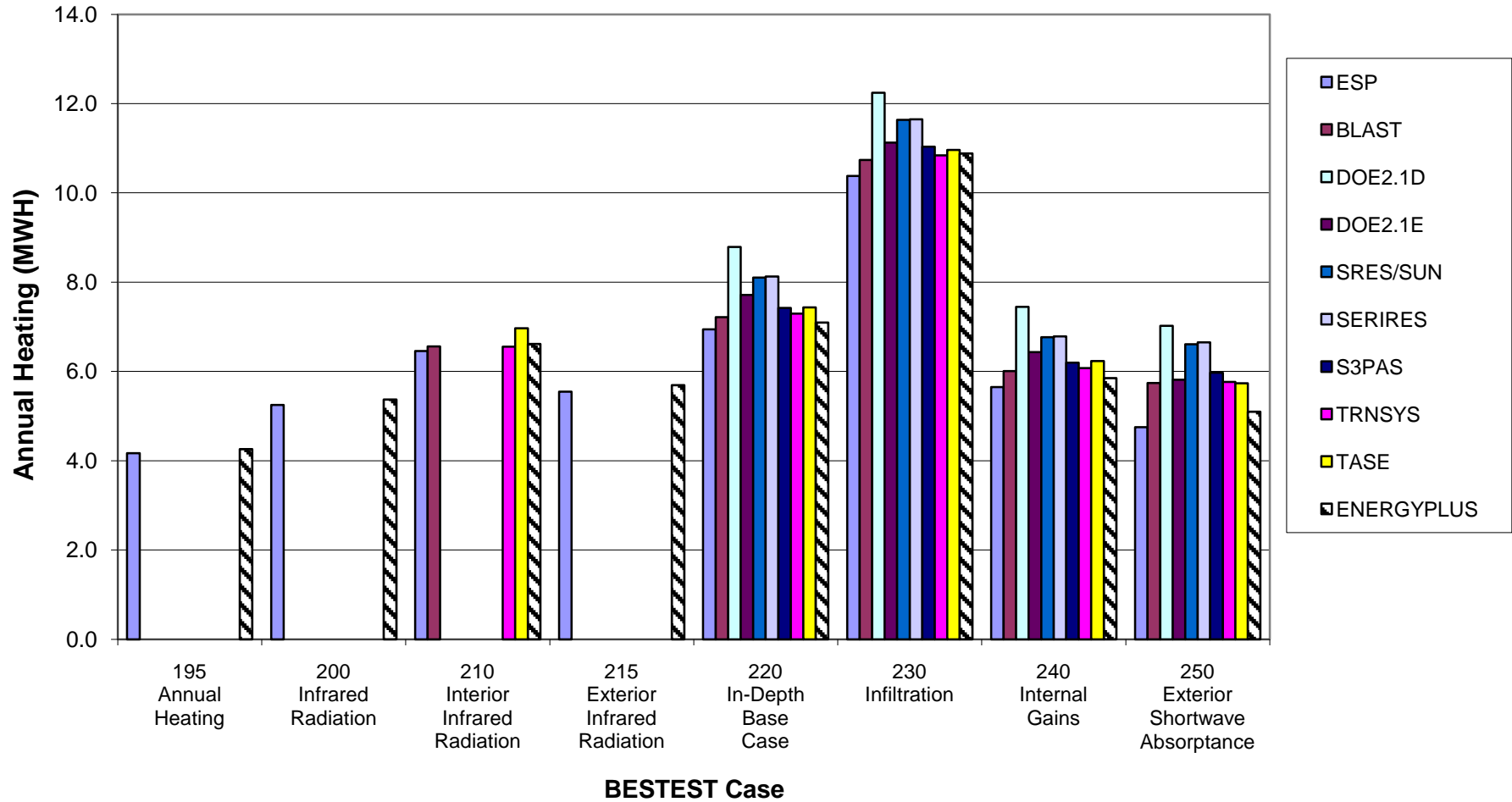

Standard 140-2007 In-Depth Comparison Low Mass Annual Sensible Cooling Cases 195 to 250 EnergyPlus Version 6.0.0.023

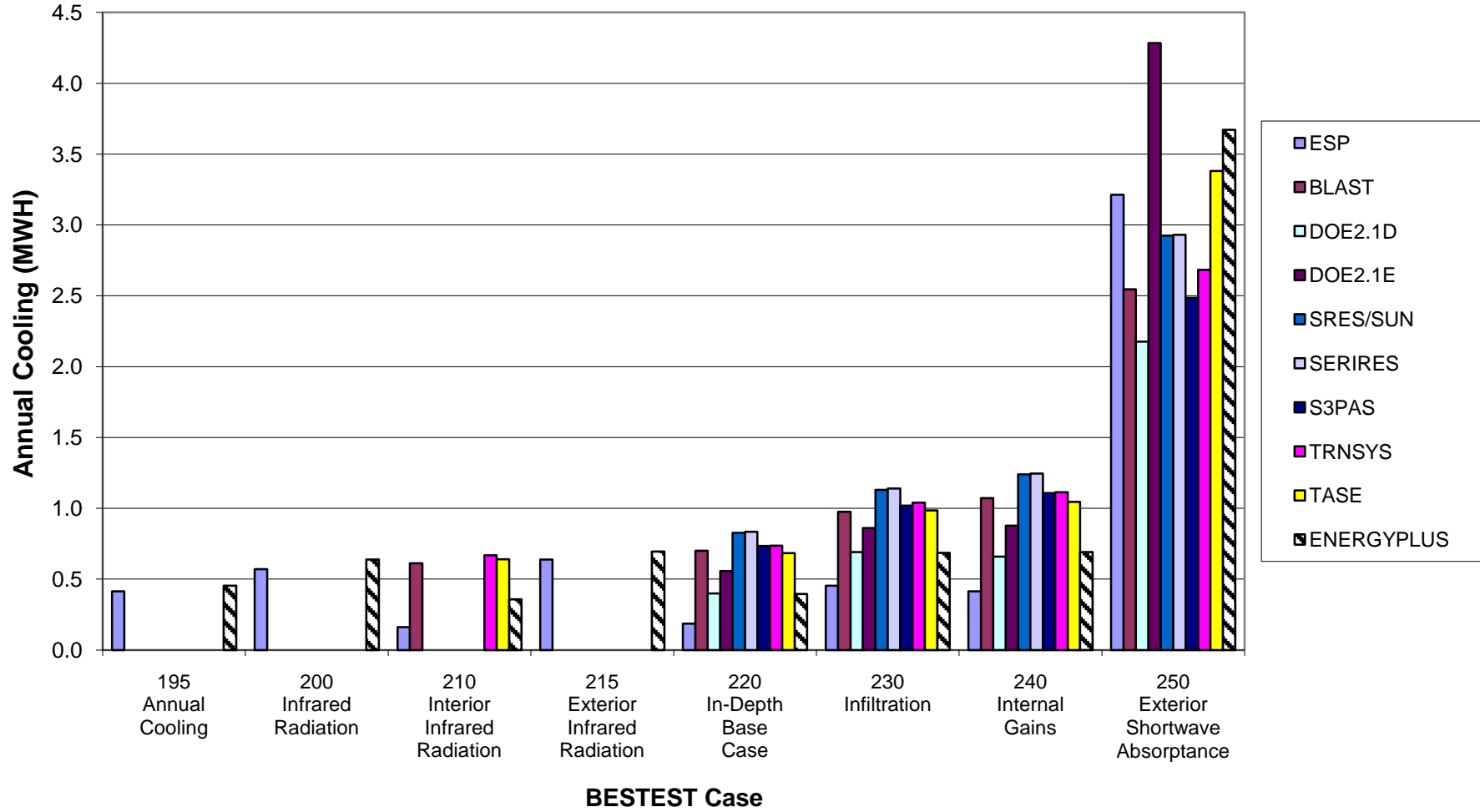

Standard 140-2007 In-Depth Comparison

Low Mass Peak Heating

Cases 195 to 250

EnergyPlus Version 6.0.0.023

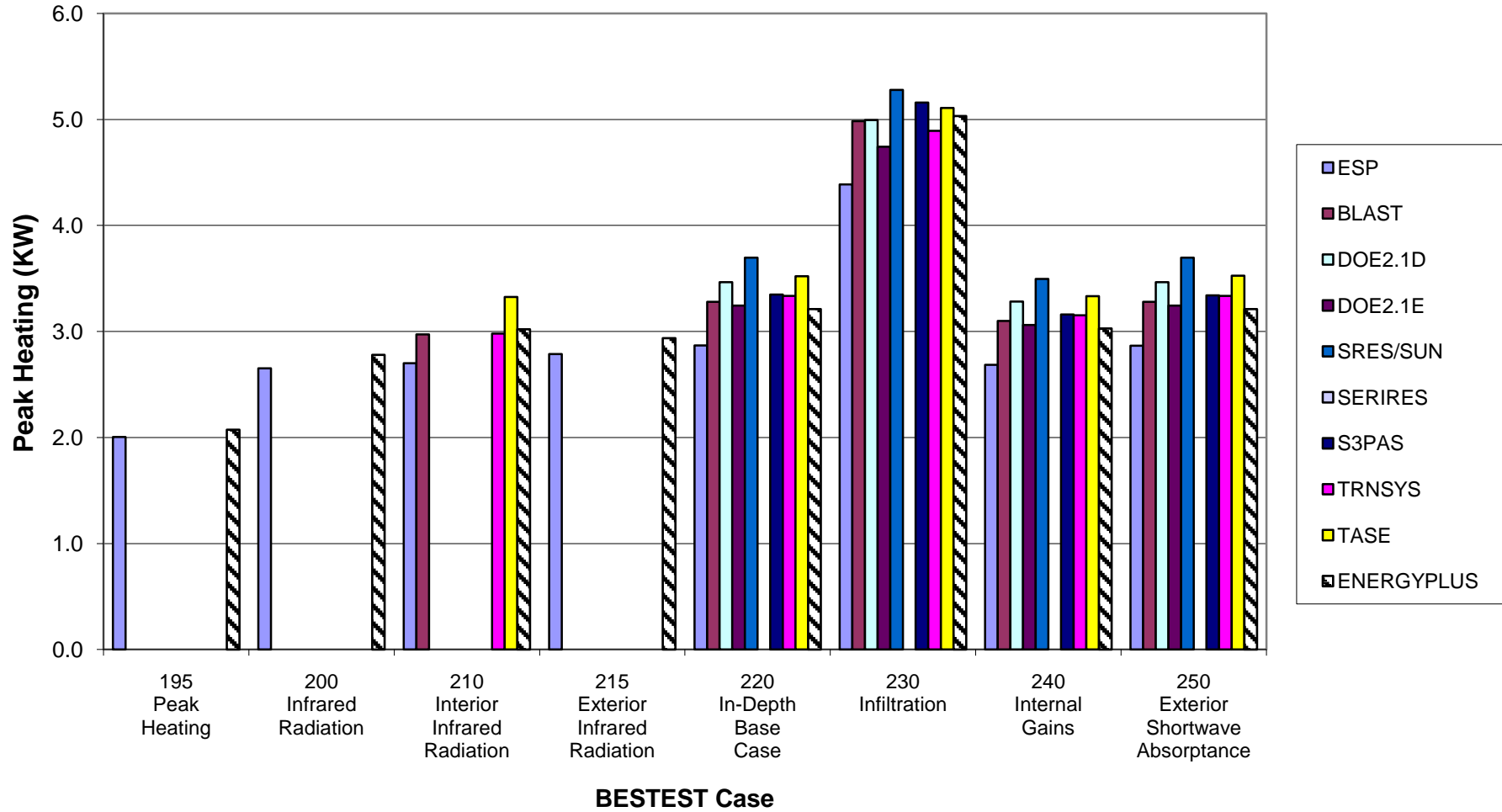

Standard 140-2007 In-Depth Comparison

Low Mass Peak Sensible Cooling

Cases 195 to 250

EnergyPlus Version 6.0.0.023

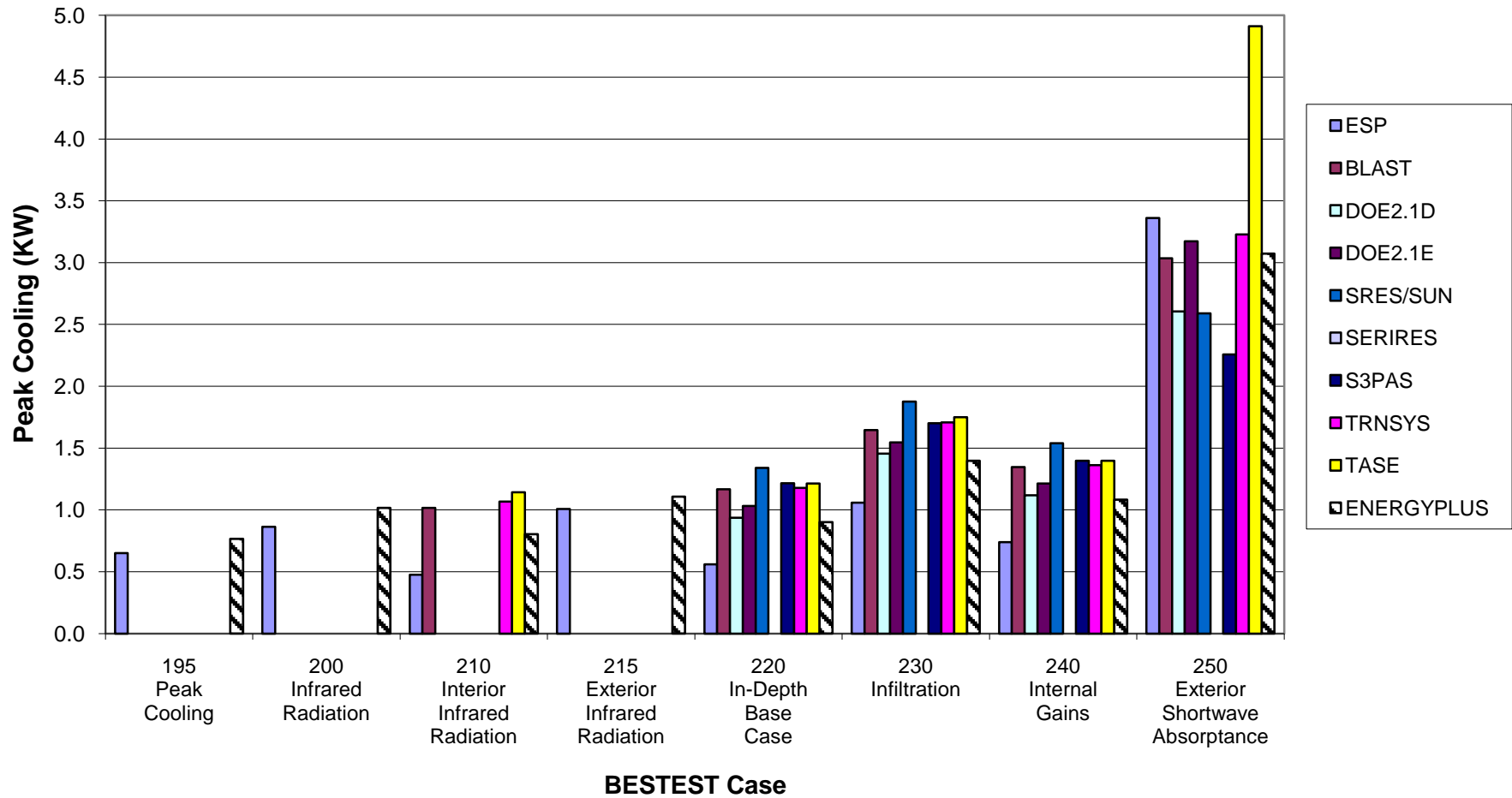

Standard 140-2007 In-Depth Comparison

Low Mass Annual Heating

Cases 270 to 320

EnergyPlus Version 6.0.0.023

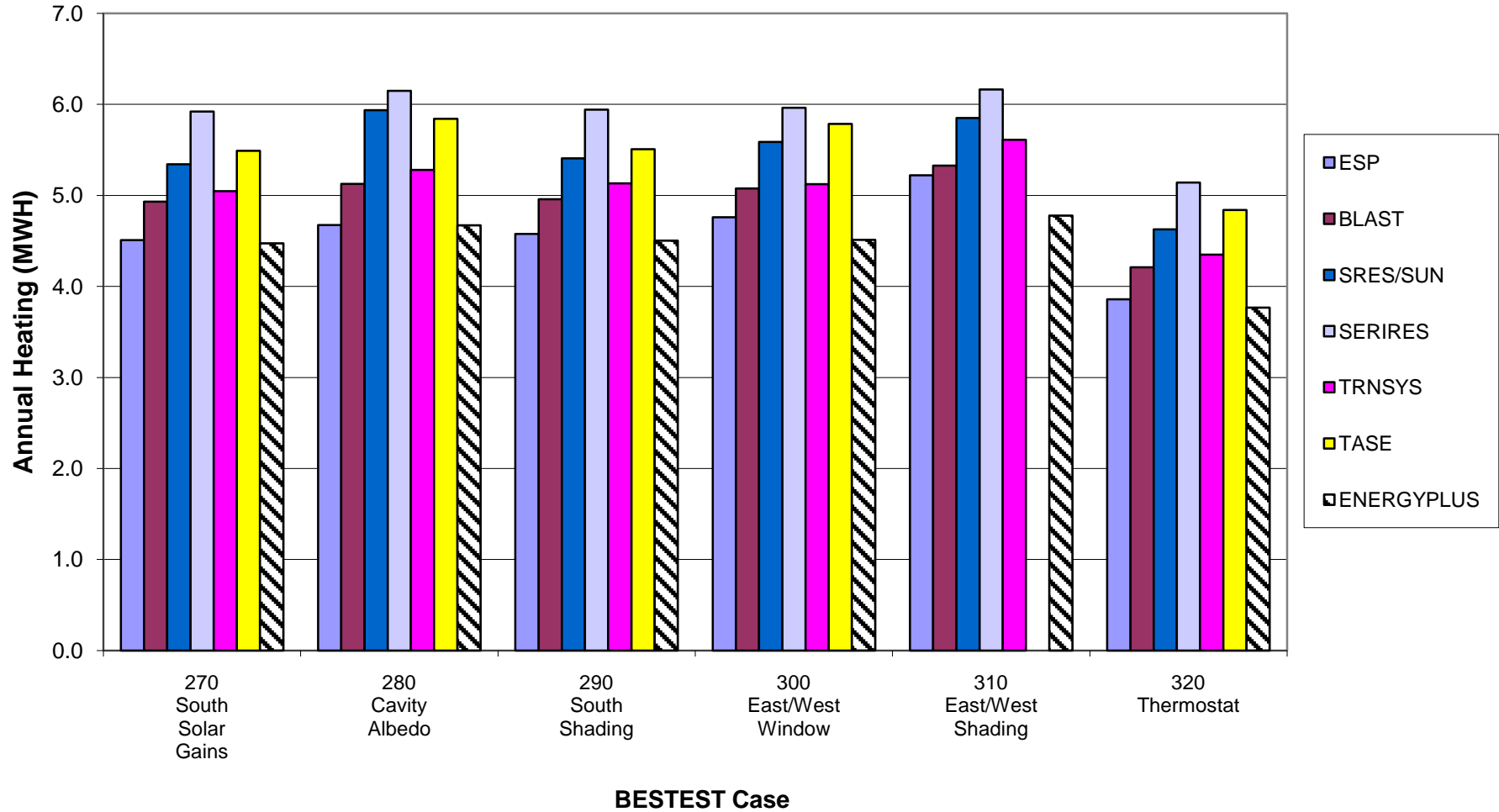

Standard 140-2007 In-Depth Comparison Low Mass Annual Sensible Cooling Cases 270 to 320 EnergyPlus Version 6.0.0.023

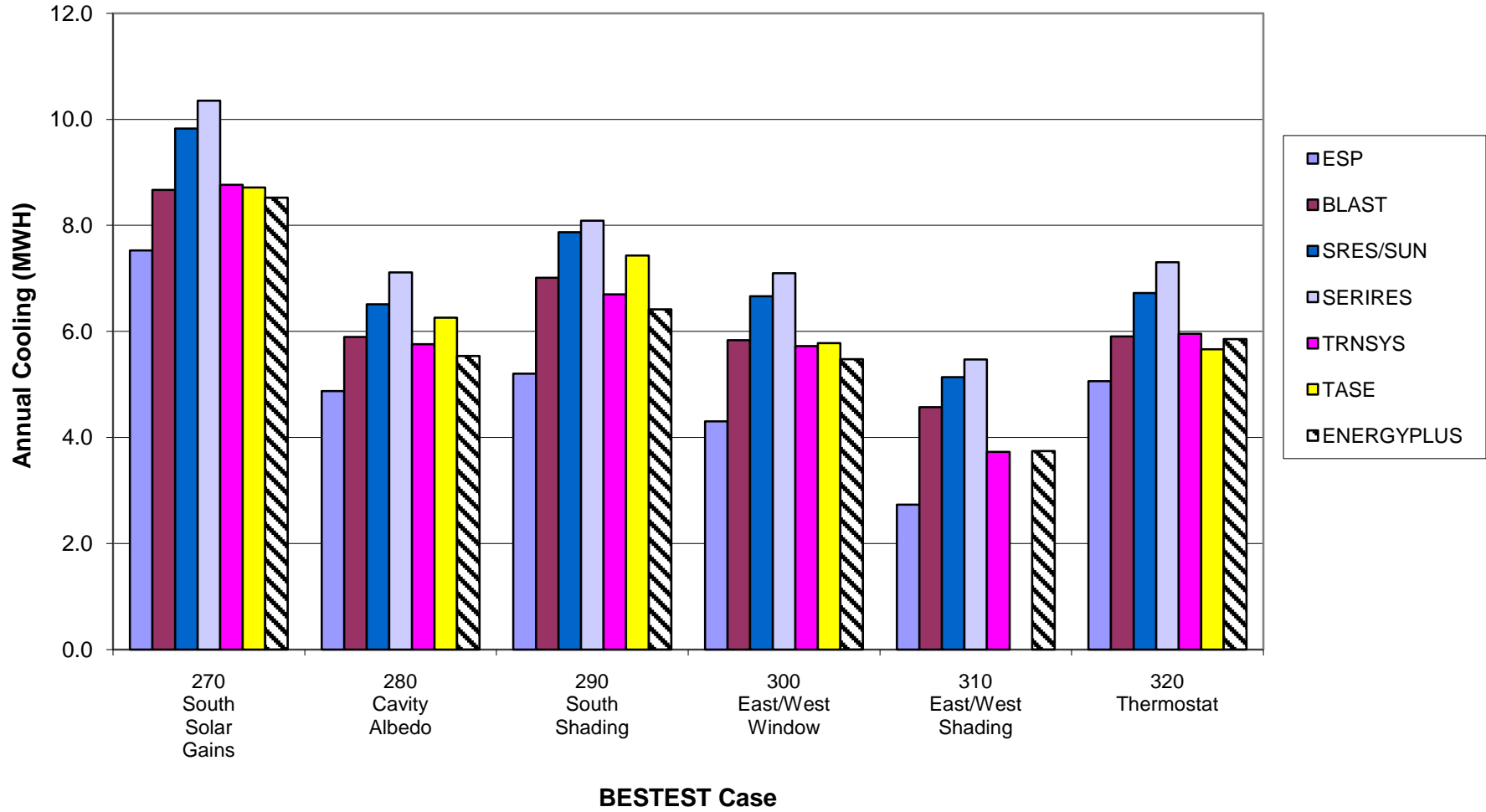

**Standard 140-2007 In-Depth Comparison
Low Mass Peak Heating
Cases 270 to 320
EnergyPlus Version 6.0.0.023**

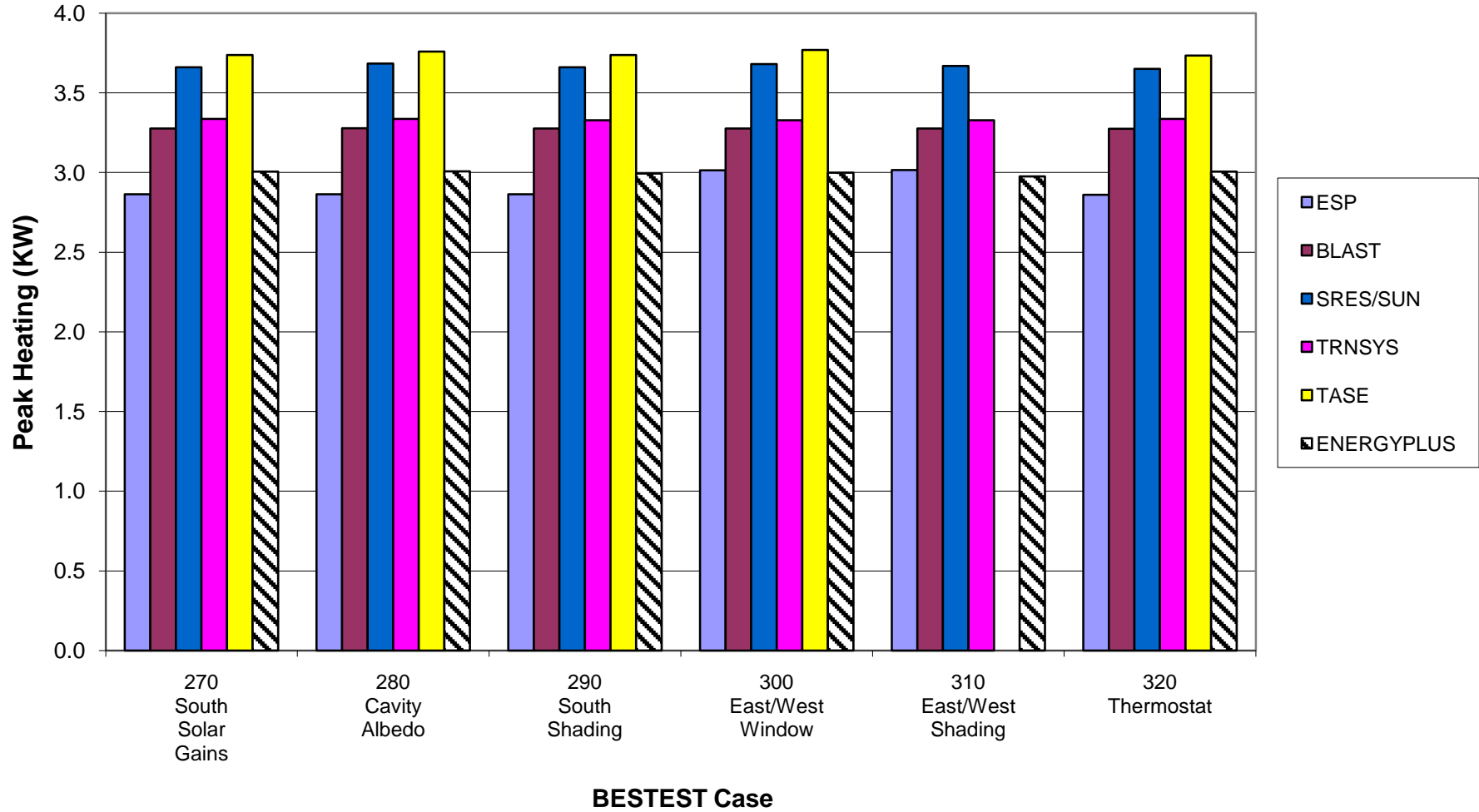

Standard 140-2007 In-Depth Comparison Low Mass Peak Sensible Cooling Cases 270 to 320 EnergyPlus Version 6.0.0.023

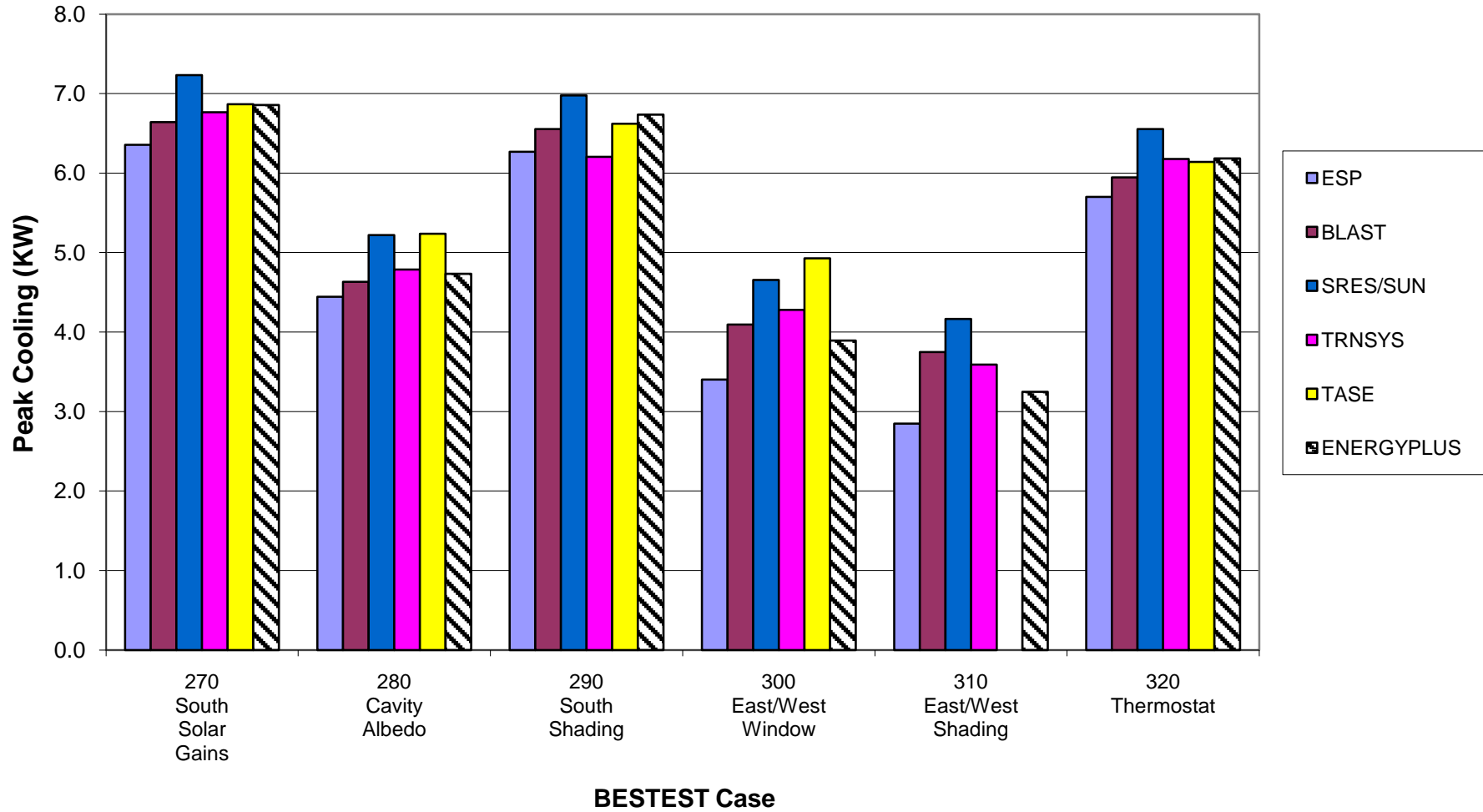

Standard 140-2007 In-Depth Comparison Low & High Mass Building Annual Sensible Cooling Cases 395 to 440, 800, 810 EnergyPlus Version 6.0.0.023

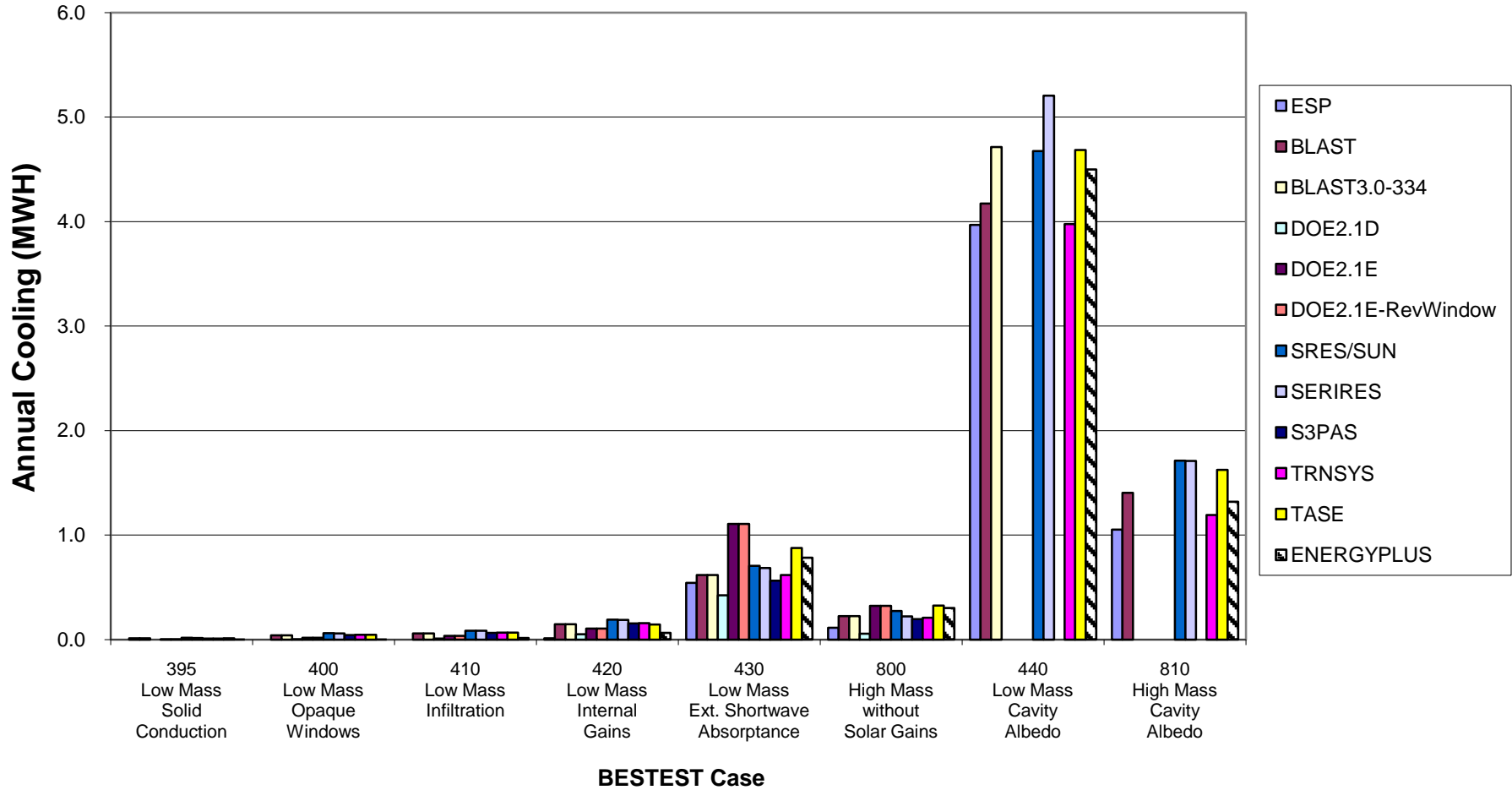

Standard 140-2007 In-Depth Comparison Low & High Mass Building Peak Heating Cases 395 to 440, 800, 810 EnergyPlus Version 6.0.0.023

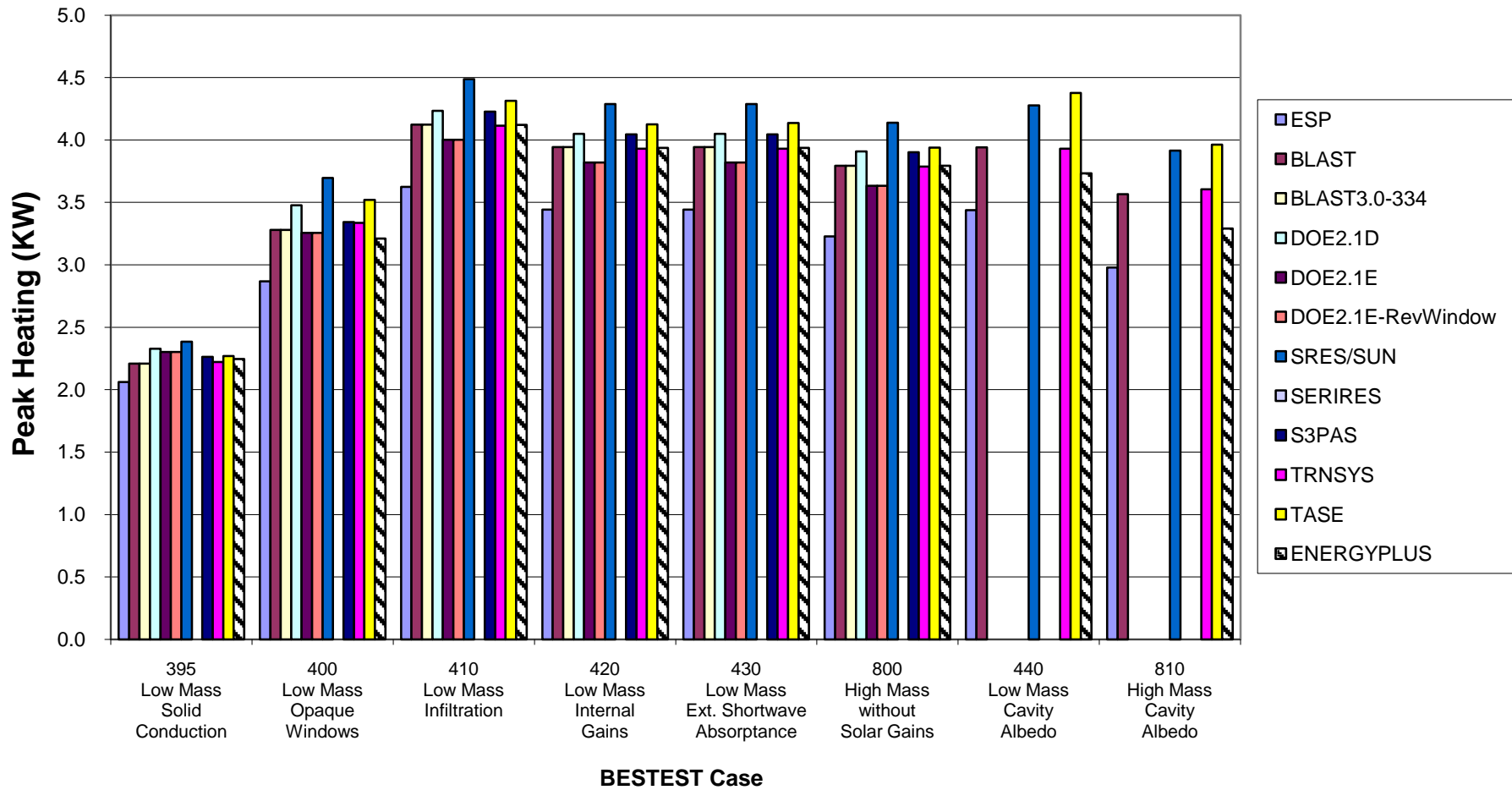

Standard 140-2007 In-Depth Comparison Low & High Mass Building Peak Sensible Cooling Cases 395 to 440, 800, 810

EnergyPlus Version 6.0.0.023

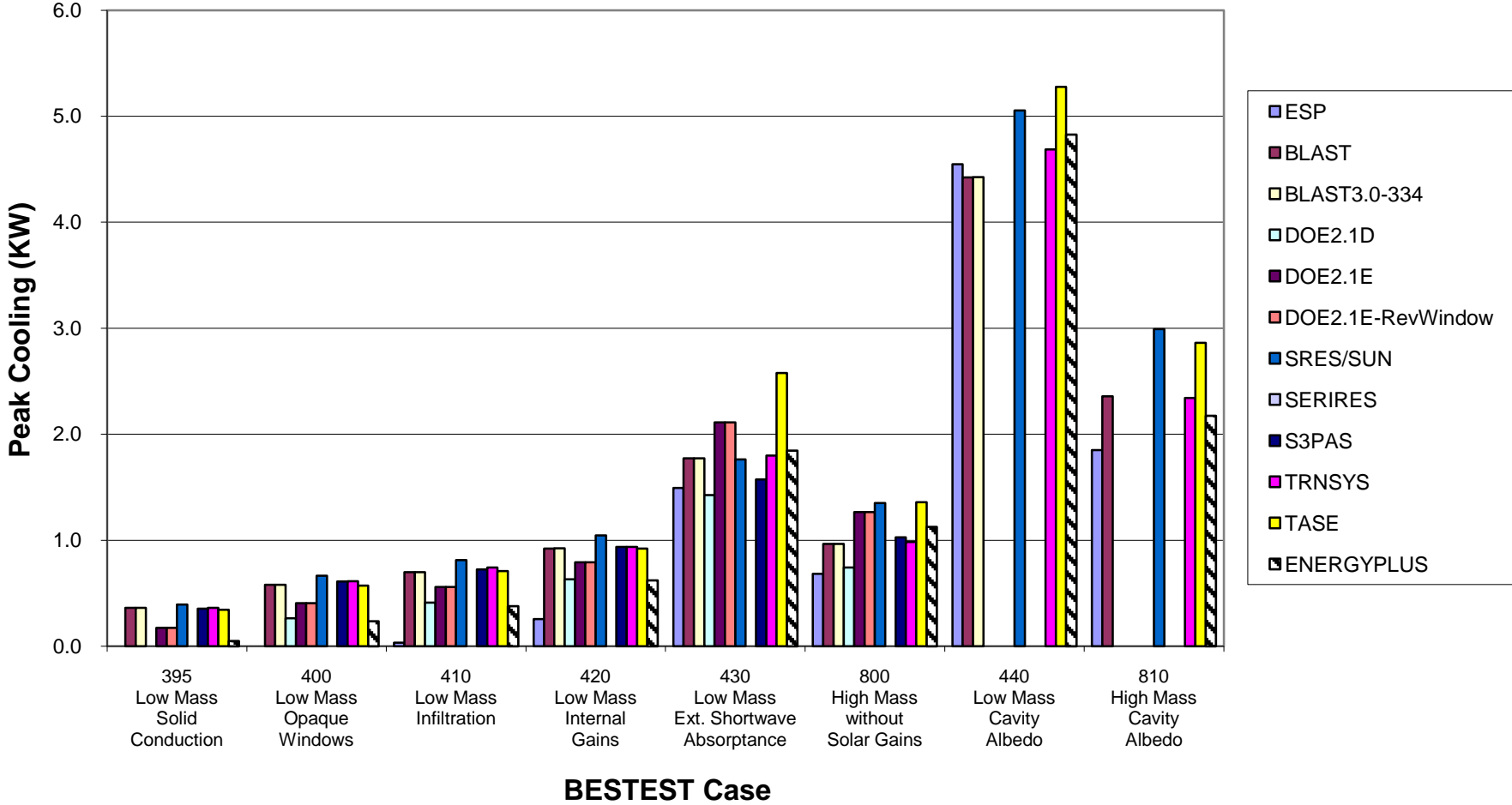

Standard 140-2007 In-Depth Comparison Cases 220 to 270 (Delta) Annual Heating and Sensible Cooling EnergyPlus Version 6.0.0.023

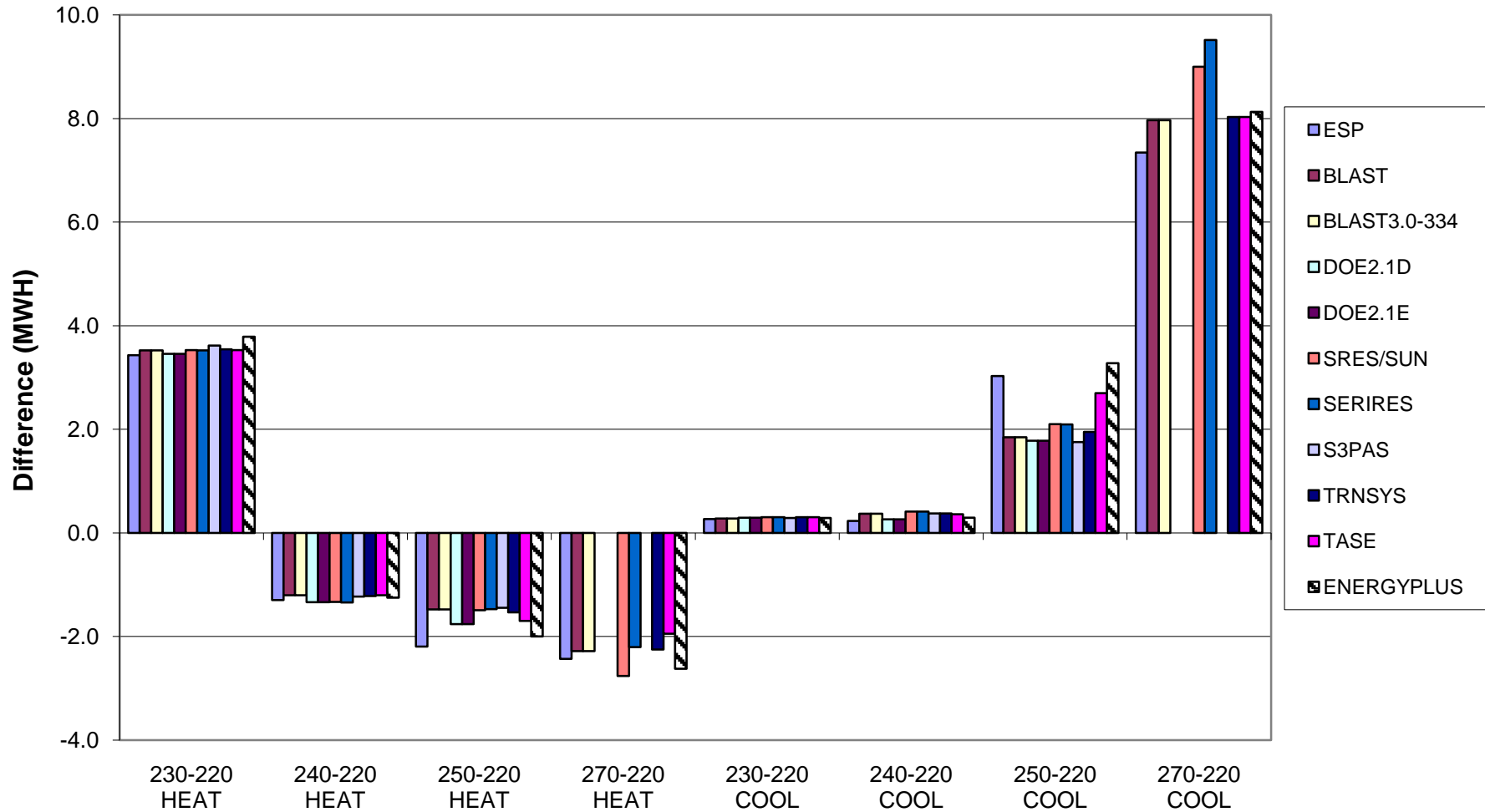

Standard 140-2007 In-Depth Comparison Cases 220 to 270 (Delta) Peak Heating and Sensible Cooling EnergyPlus Version 6.0.0.023

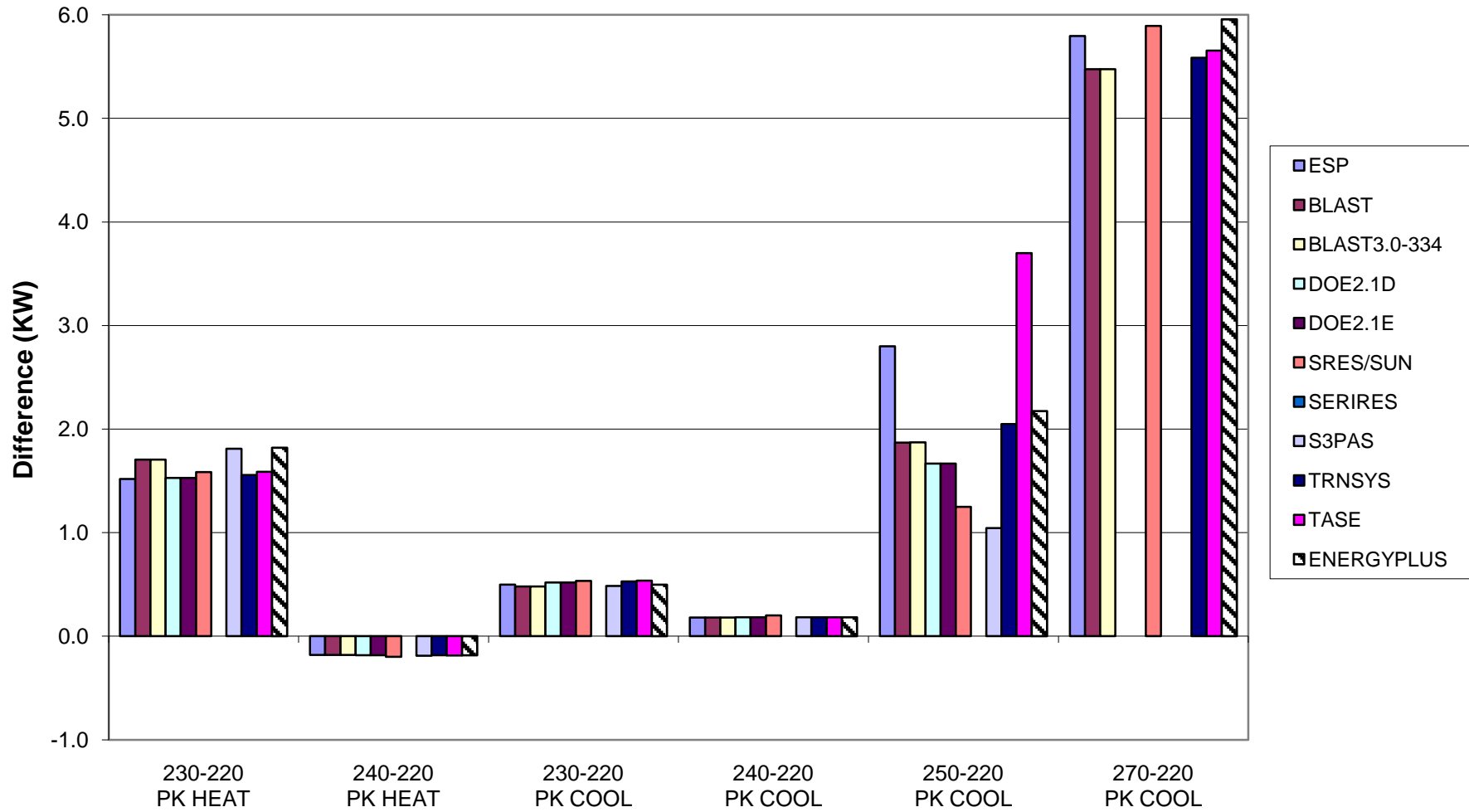

Standard 140-2007 In-Depth Comparison Cases 270 to 320 (Delta) Annual Heating and Sensible Cooling EnergyPlus Version 6.0.0.023

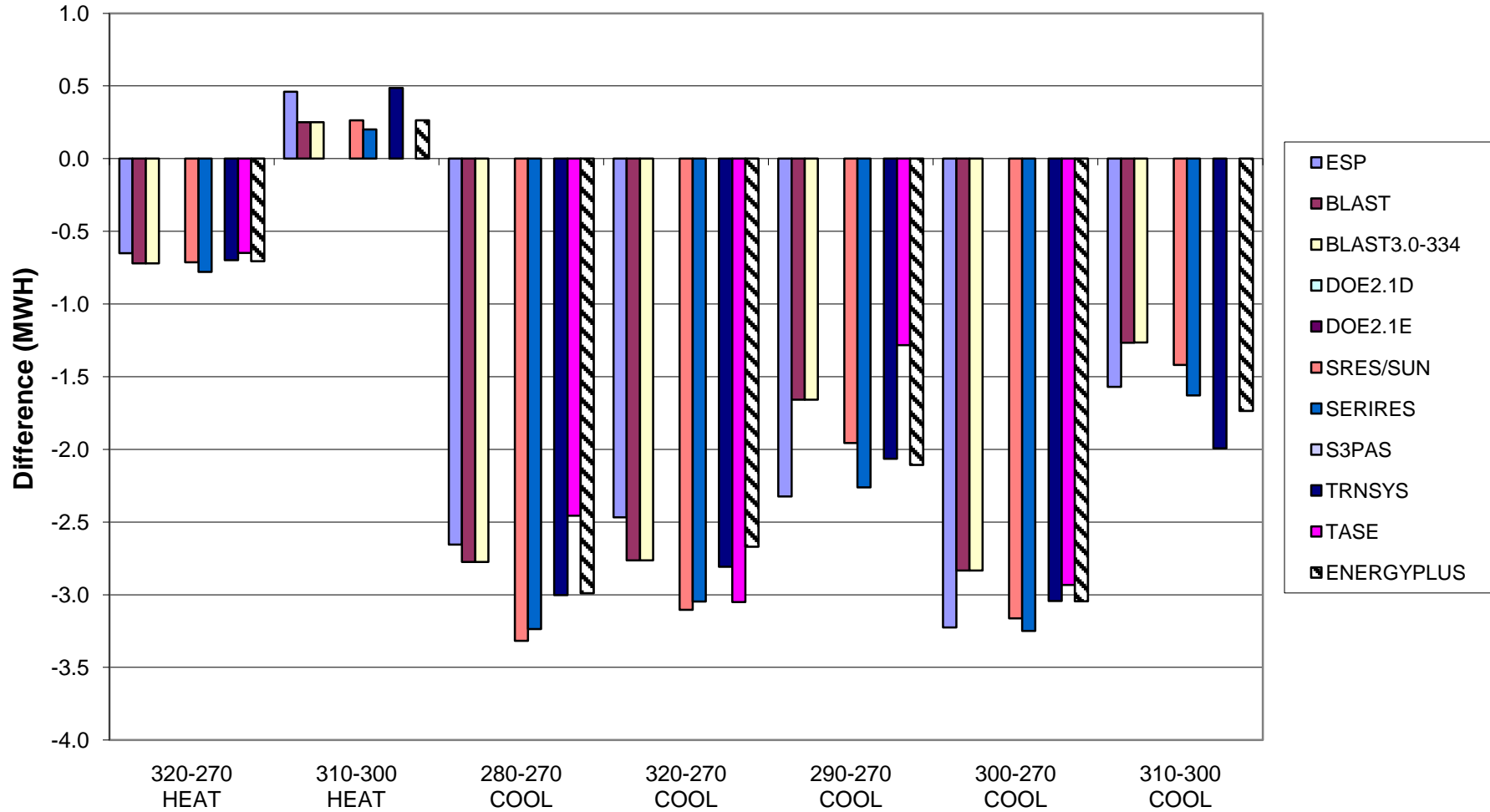

Standard 140-2007 In-Depth Comparison Cases 270 to 320 (Delta) Peak Sensible Cooling EnergyPlus Version 6.0.0.023

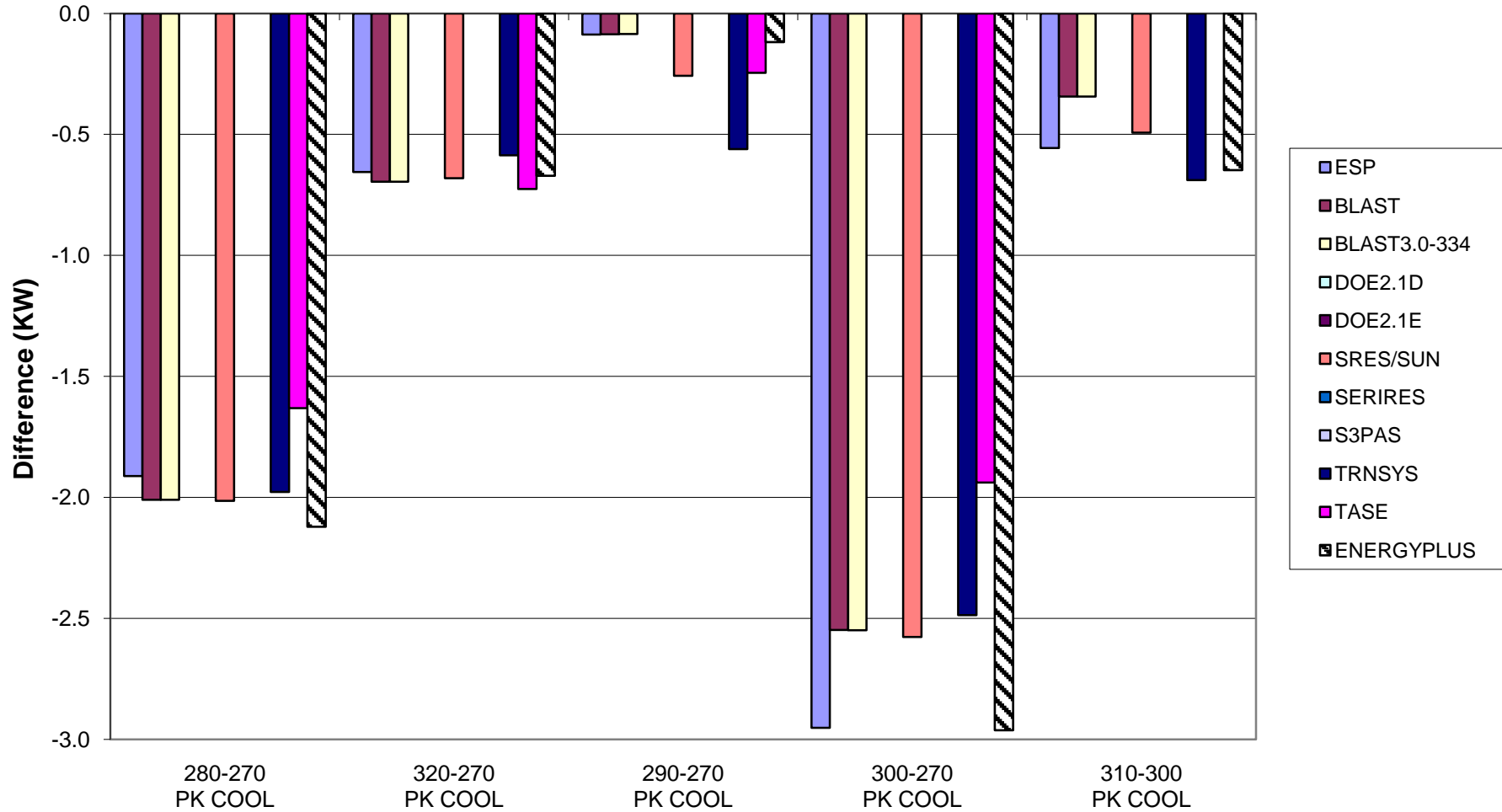

Standard 140-2007 In-Depth Comparison Cases 395 to 600 (Delta) Peak Heating and Sensible Cooling EnergyPlus Version 6.0.0.023

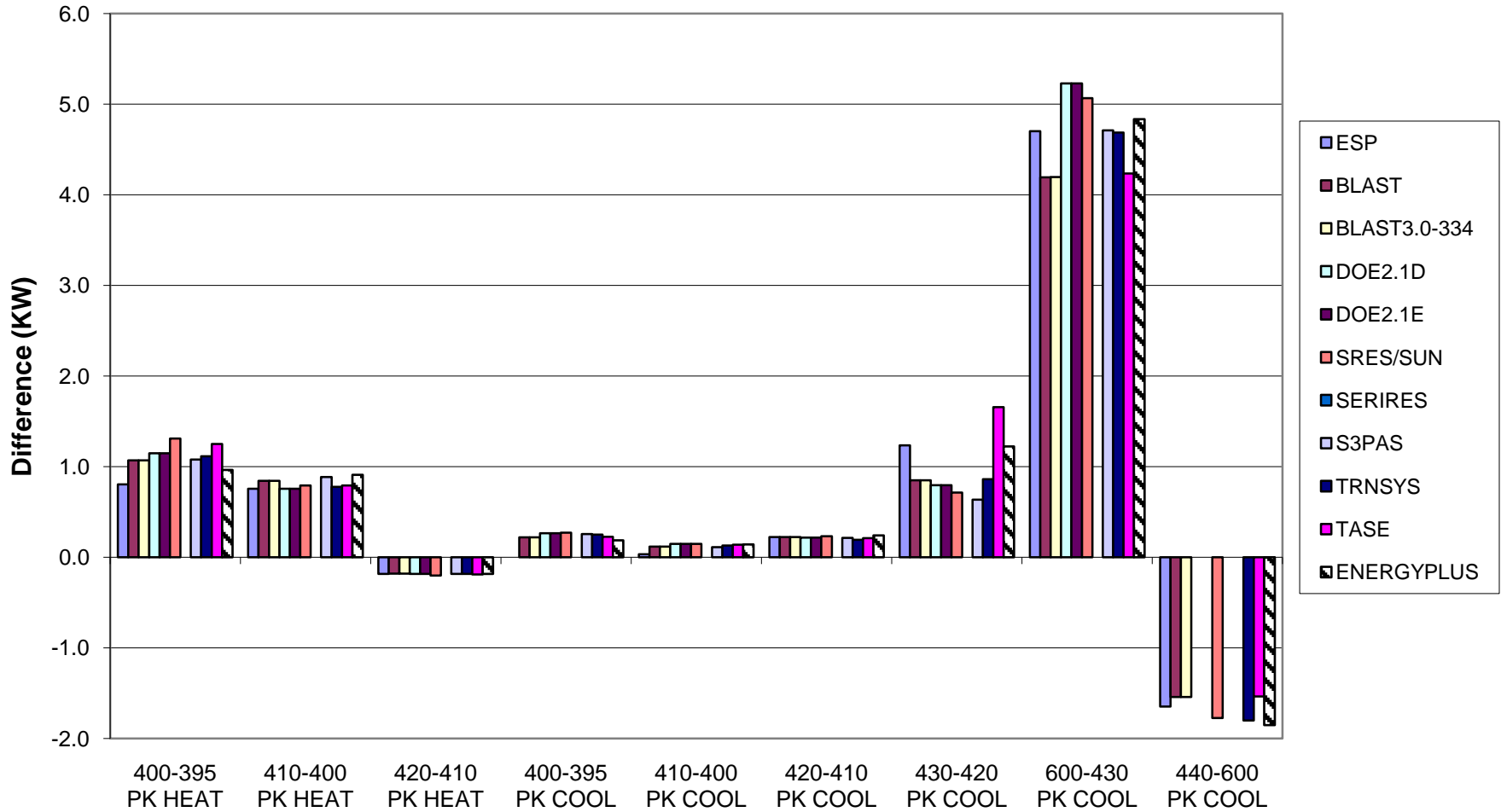

Standard 140-2007 Case 600 or 900 Cloudy & Clear Day Hourly Incident Solar South Facing Surface

EnergyPlus Version 6.0.0.023

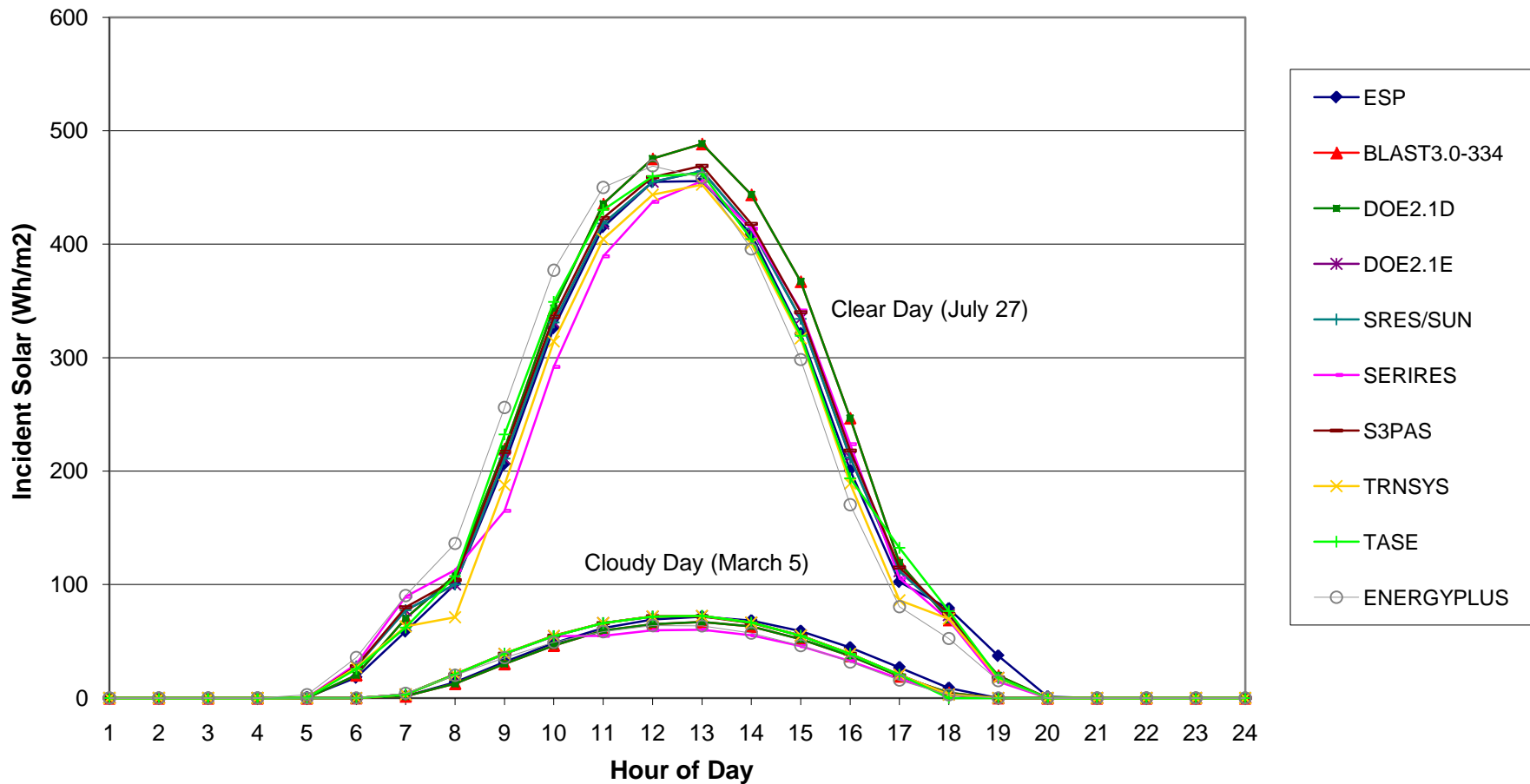

Standard 140-2007 Hourly Free Float Temperatures

Clear Cold Day

Cases 600FF and 900FF

EnergyPlus Version 6.0.0.023

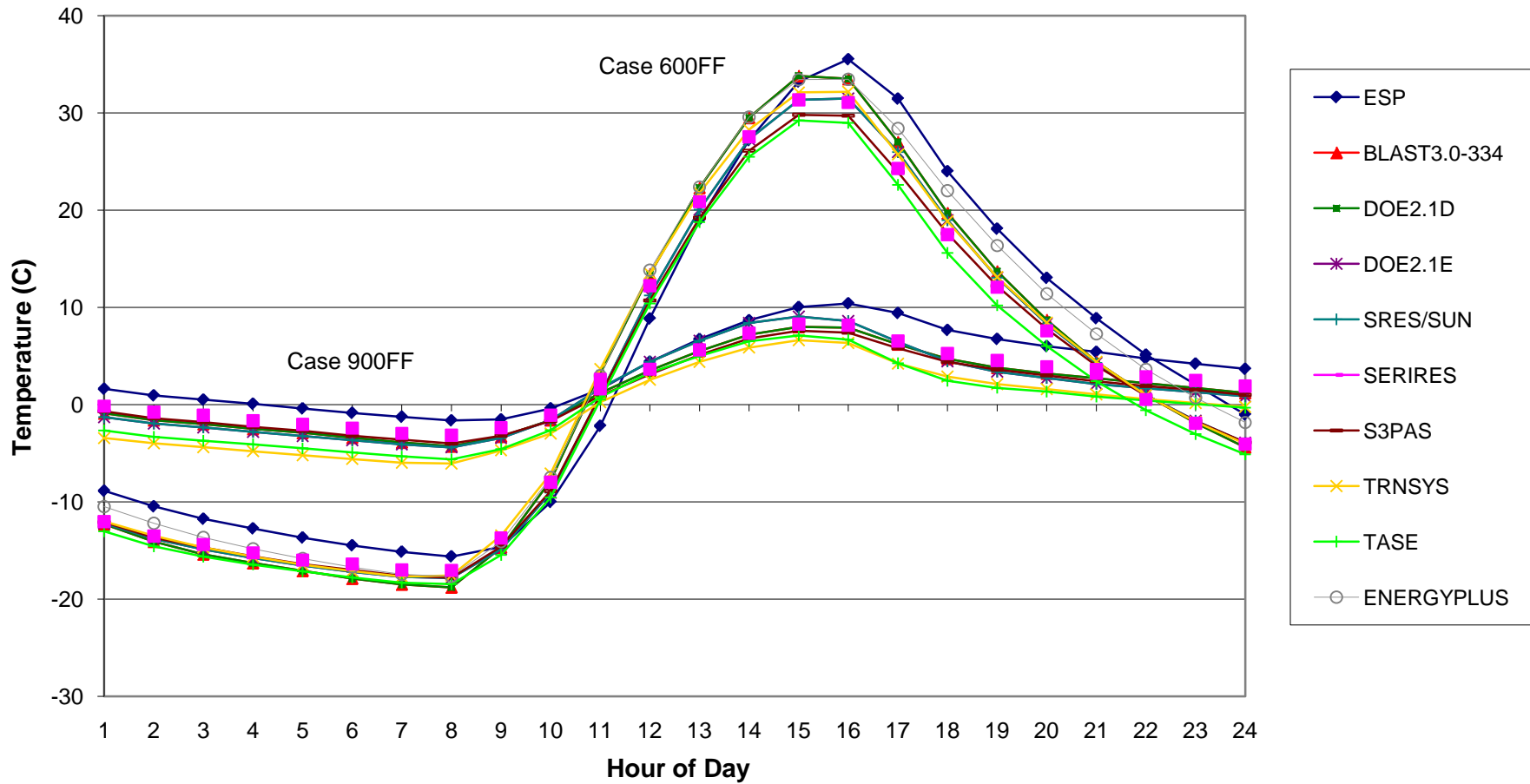

Standard 140-2007 Hourly Free Float Temperatures Clear Hot Day Cases 650FF and 950FF EnergyPlus Version 6.0.0.023

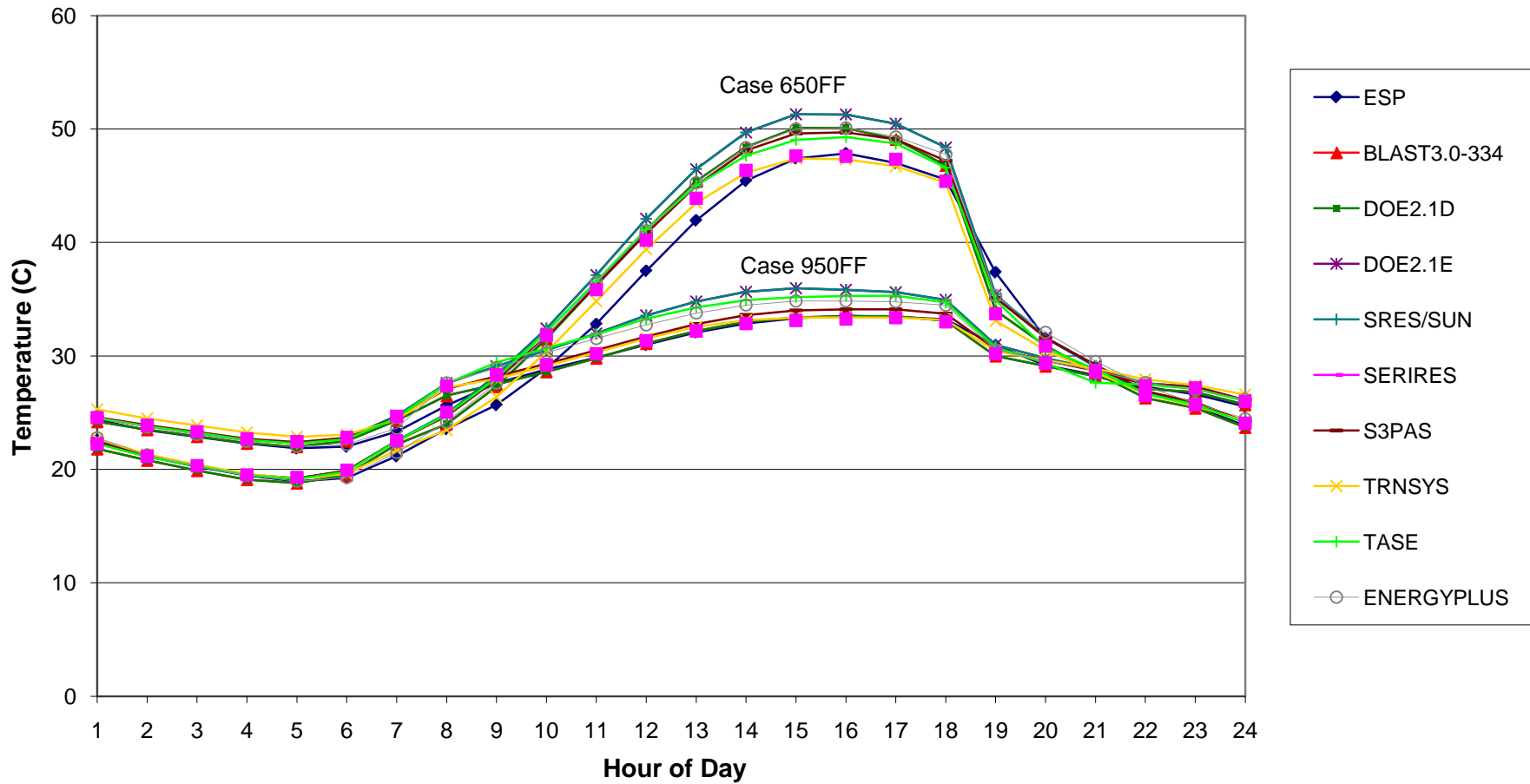

Standard 140-2007 Hourly Loads

Clear Cold Day, Case 600

Heating (+), Sensible Cooling (-)

EnergyPlus Version 6.0.0.023

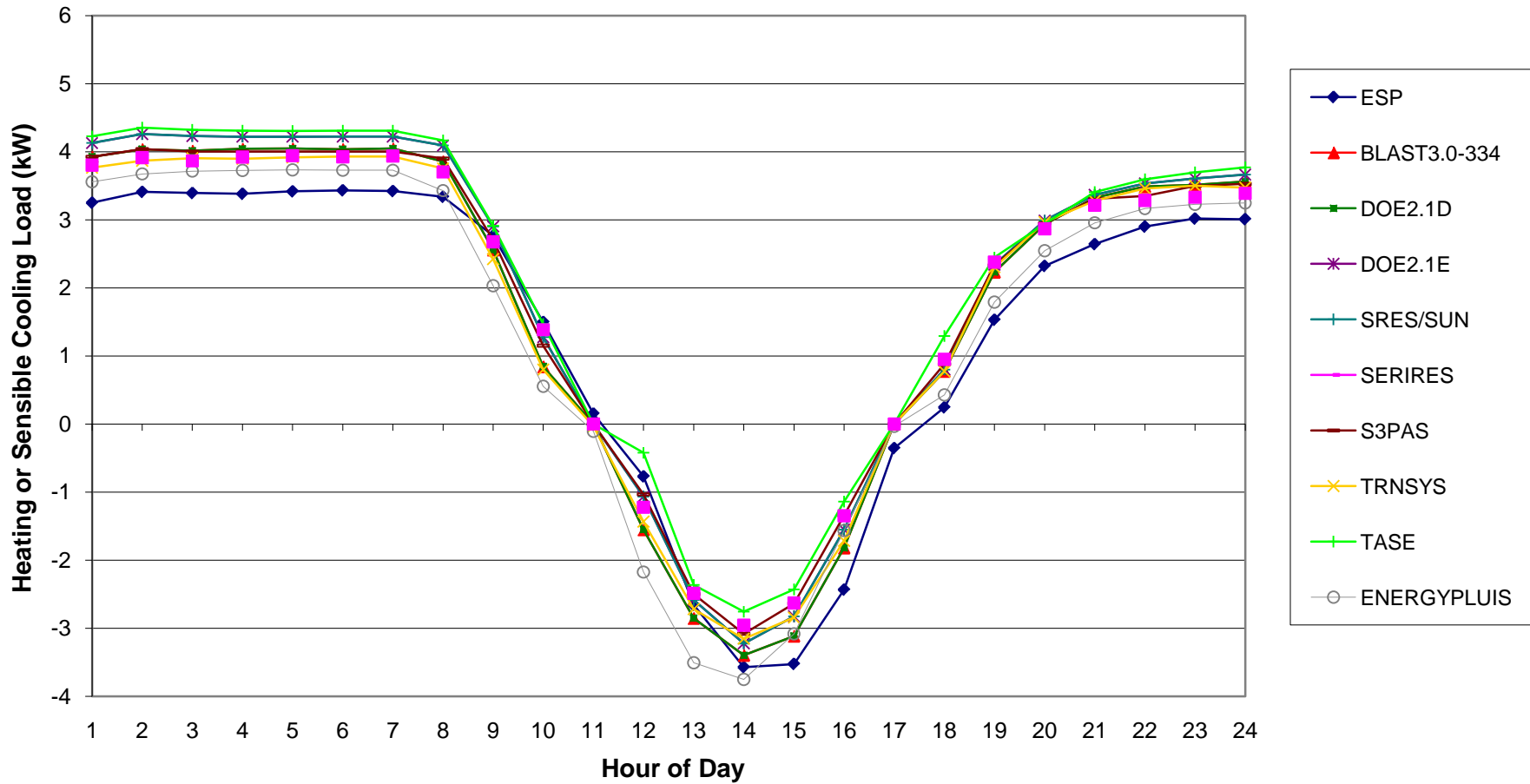

Standard 140-2007 Hourly Loads
Clear Cold Day, Case 900
Heating (+), Sensible Cooling (-)
 EnergyPlus Version 6.0.0.023

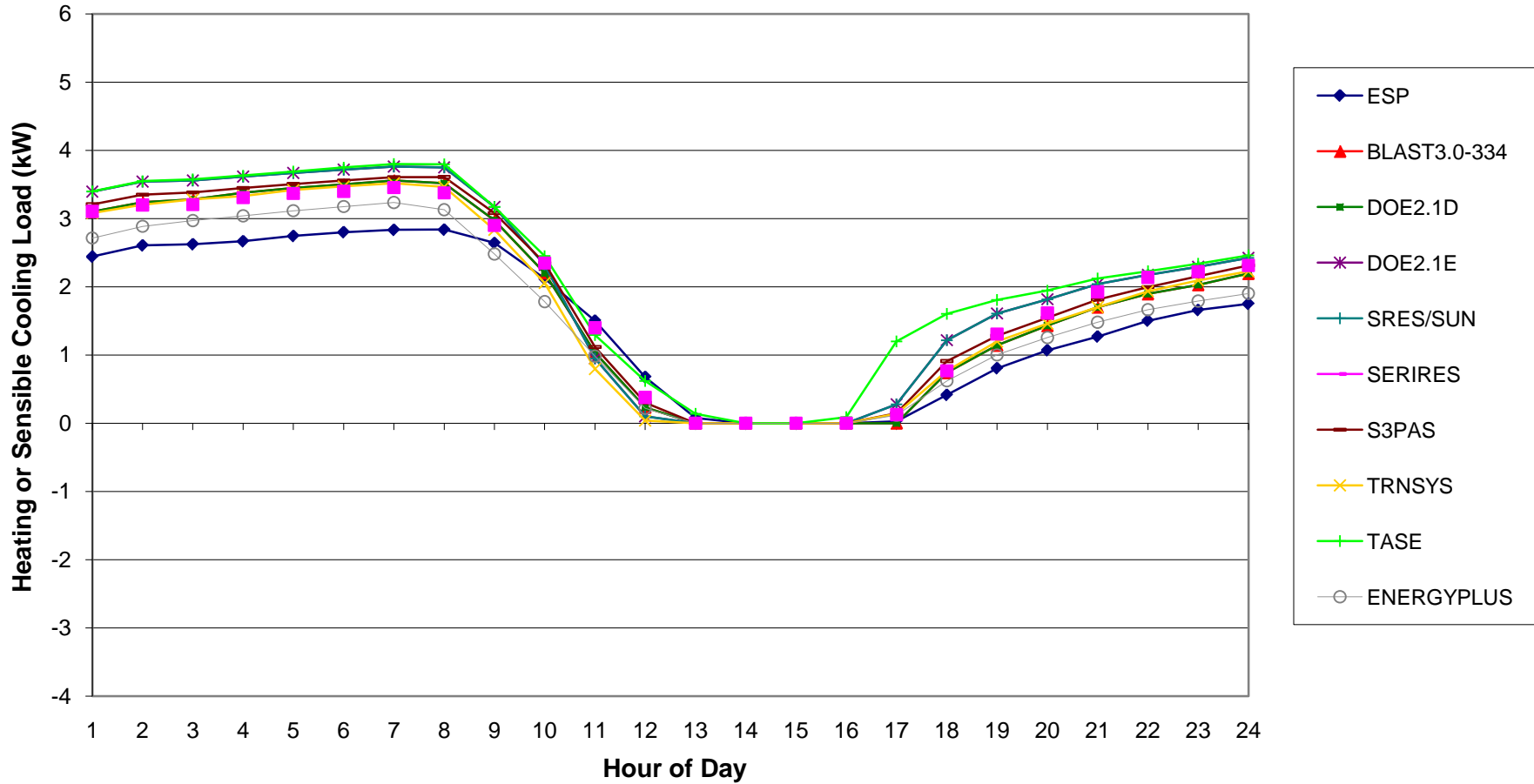

Appendix E

Historical Changes in BESTEST Results for Various Releases of EnergyPlus

Standard 140-2007 Comparison for Release Versions of EnergyPlus Low Mass Building Peak Cooling

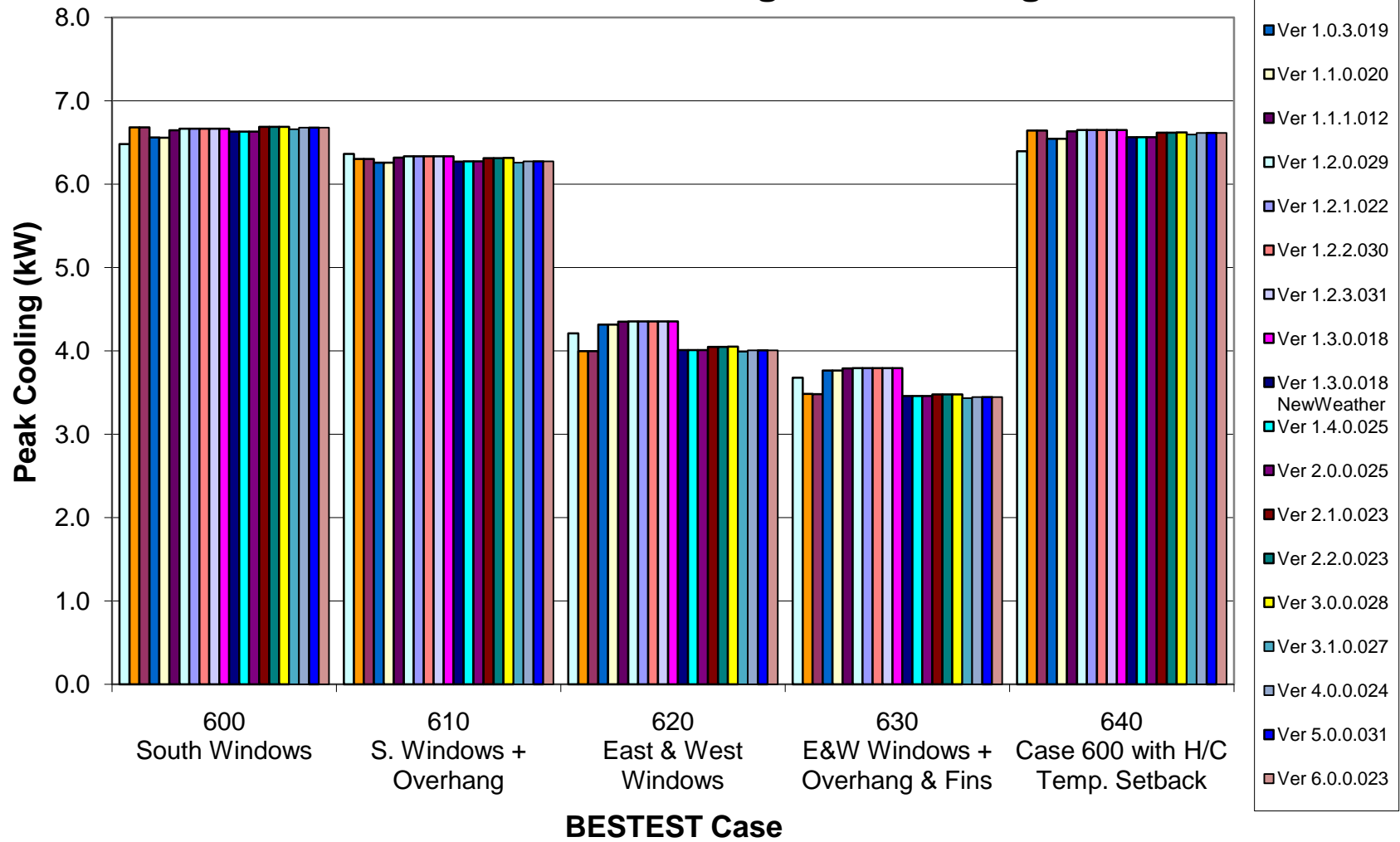

Standard 140-2007 Comparison for Release Versions of EnergyPlus Free Floating Maximum Temperature

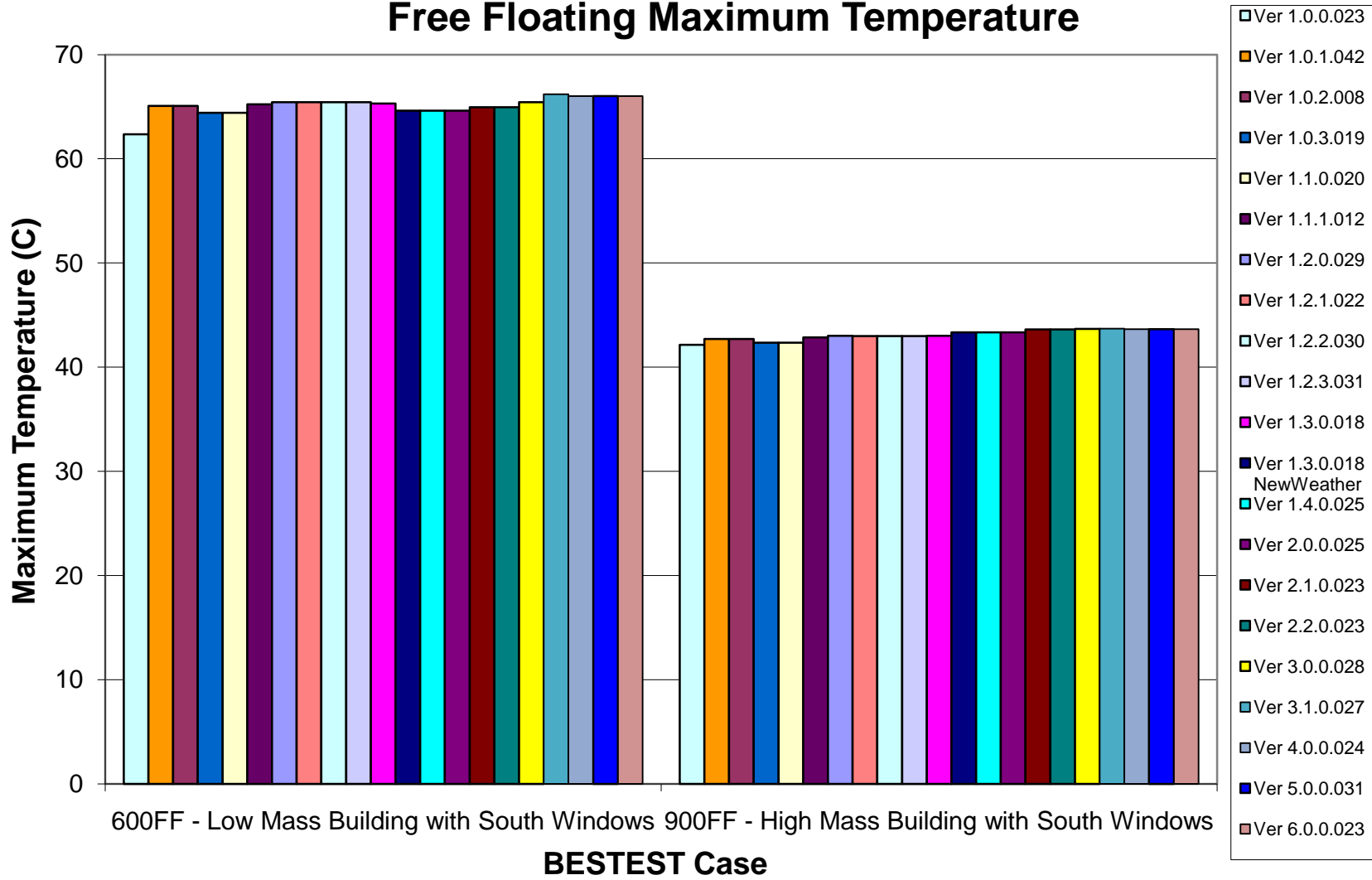

Standard 140-2007 Comparison for Release Versions of EnergyPlus Free Floating Minimum Temperature

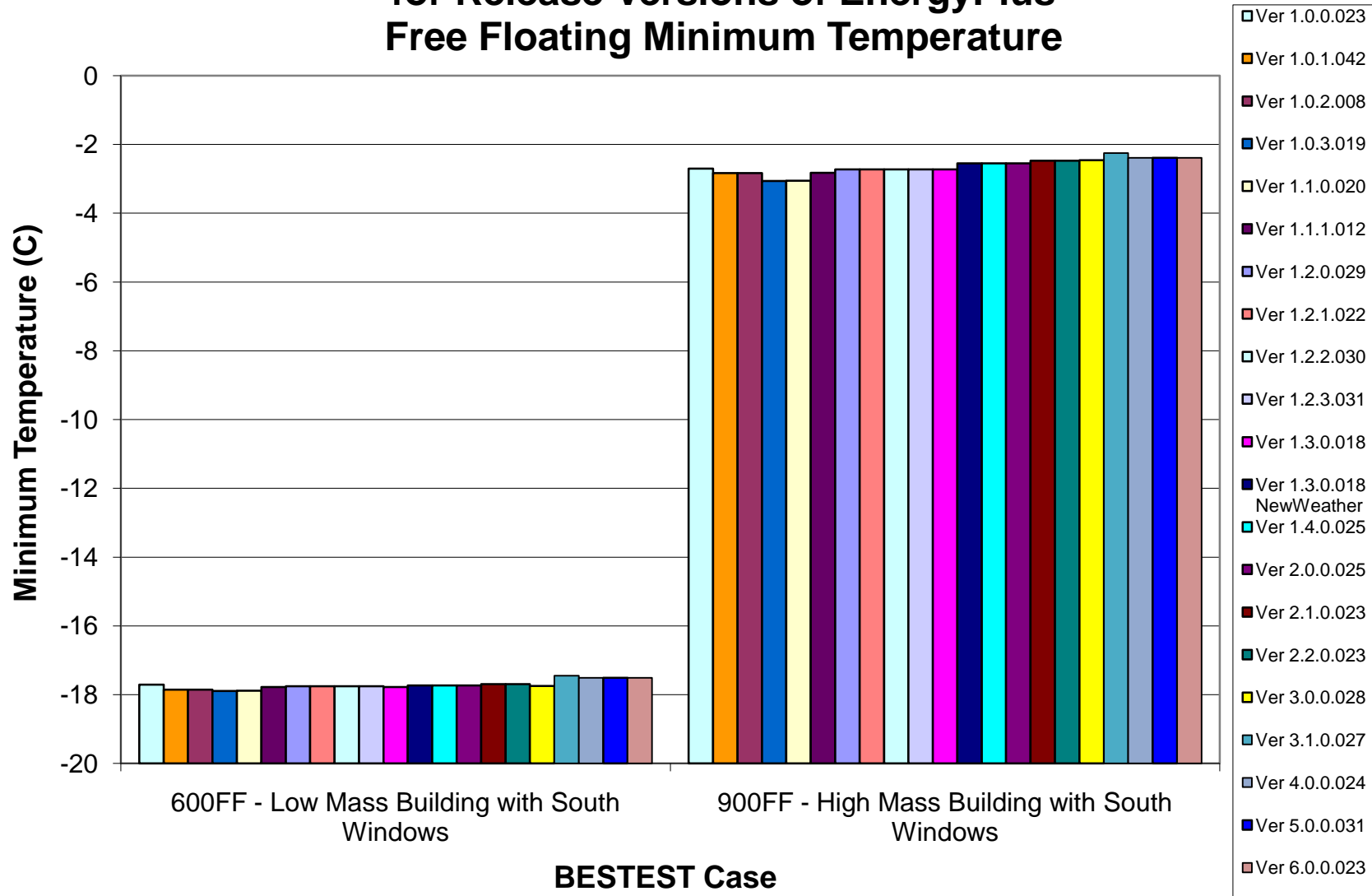

Standard 140-2007 Comparison for Release Versions of EnergyPlus Low Mass Building (low absorptances, no windows)

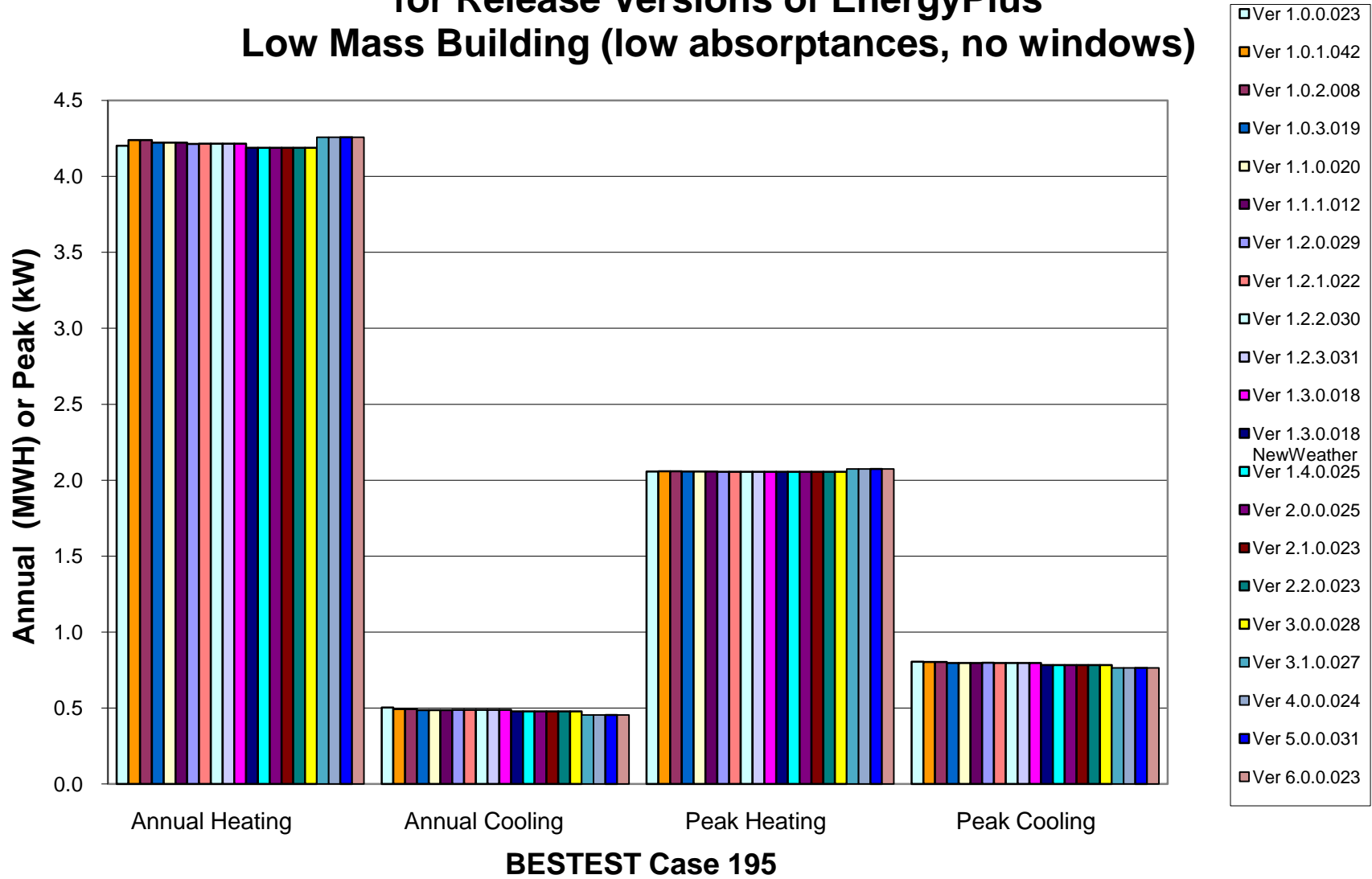

Standard 140-2007 Comparison for Release Versions of EnergyPlus South Shaded Window (Delta) Annual Heating and Cooling

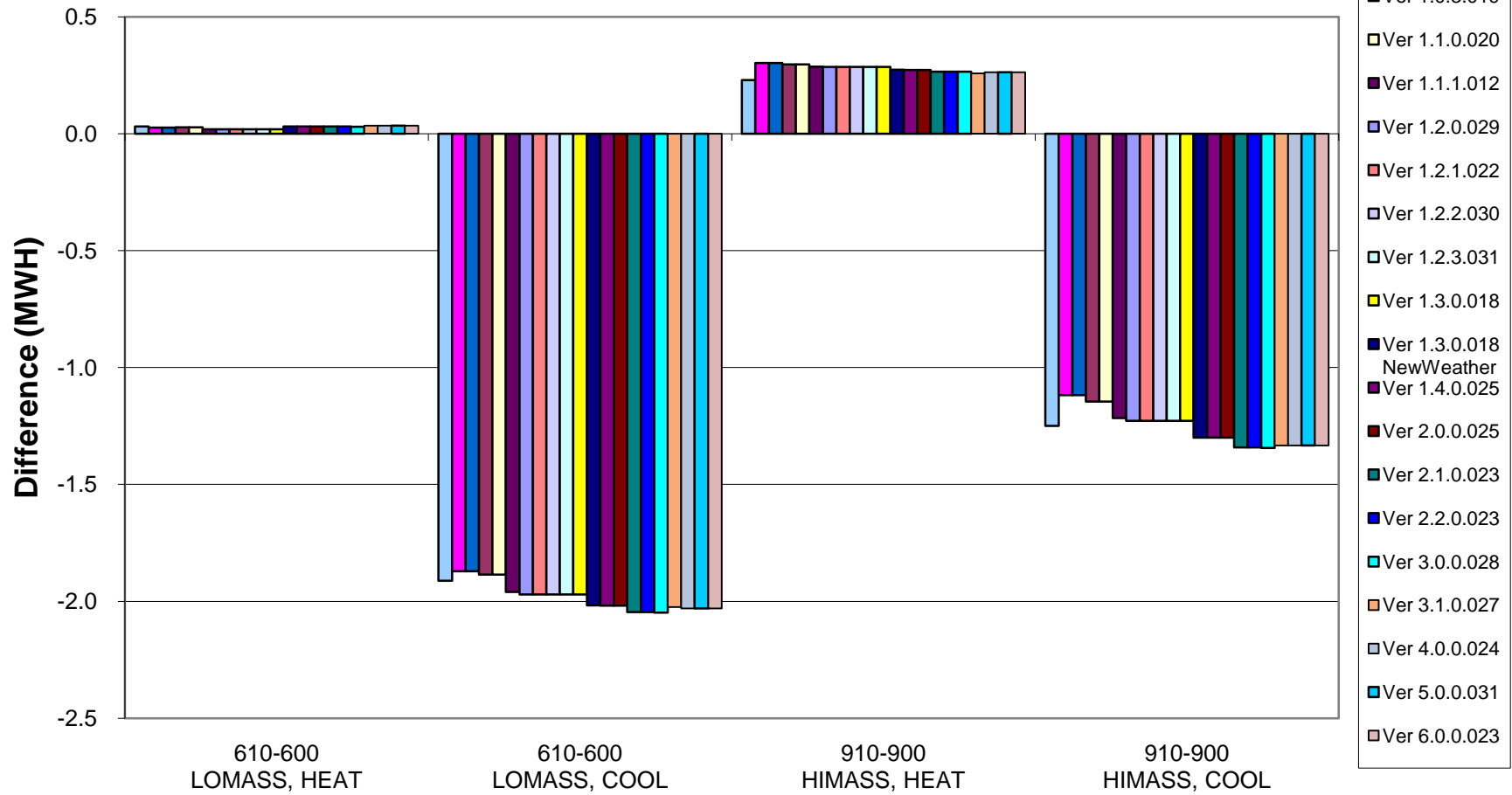

Standard 140-2007 Comparison for Release Versions of EnergyPlus East & West Window (Delta) Annual Heating and Cooling

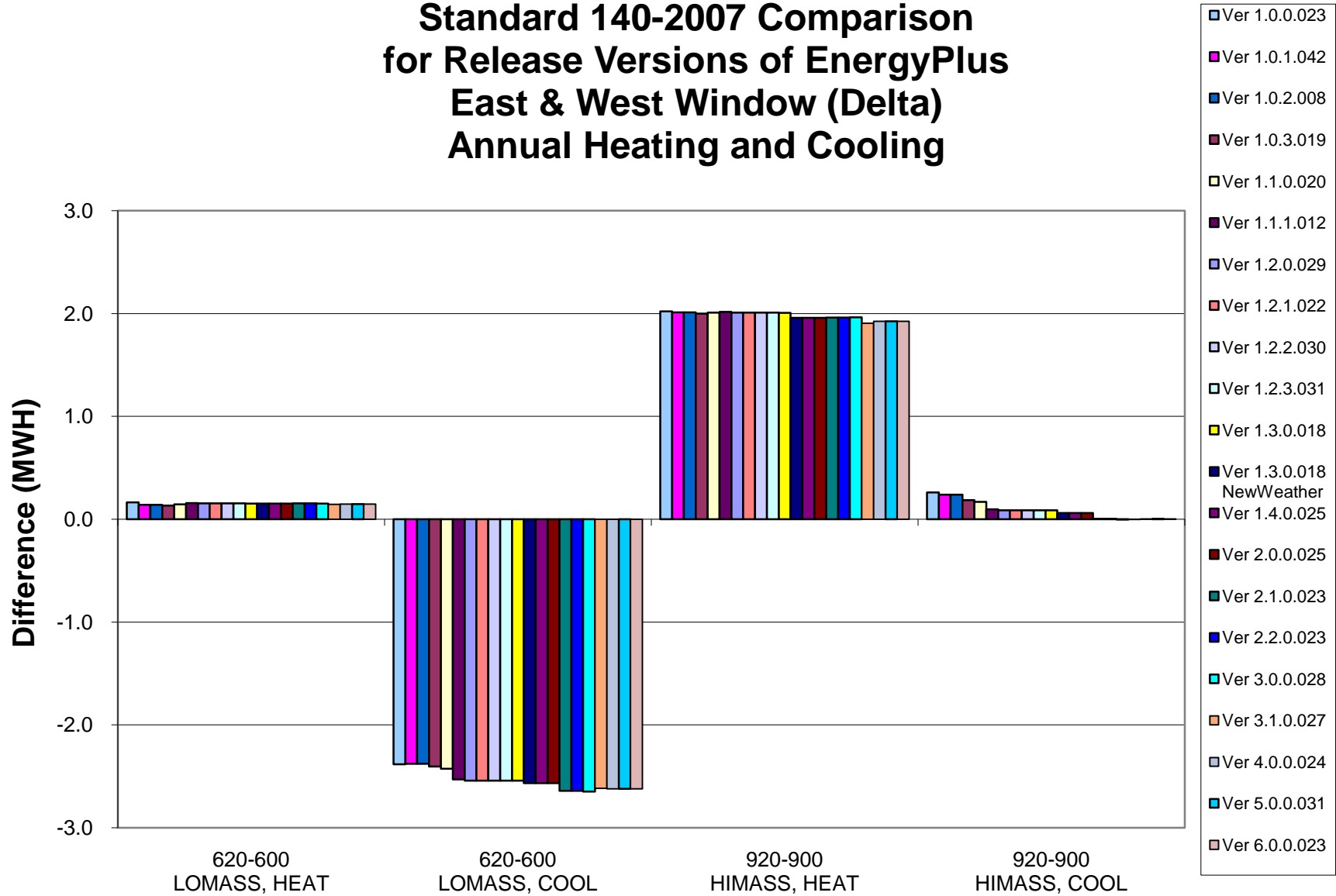

Standard 140-2007 Comparison for Release Versions of EnergyPlus Thermostat Setback (Delta) Annual Heating and Cooling

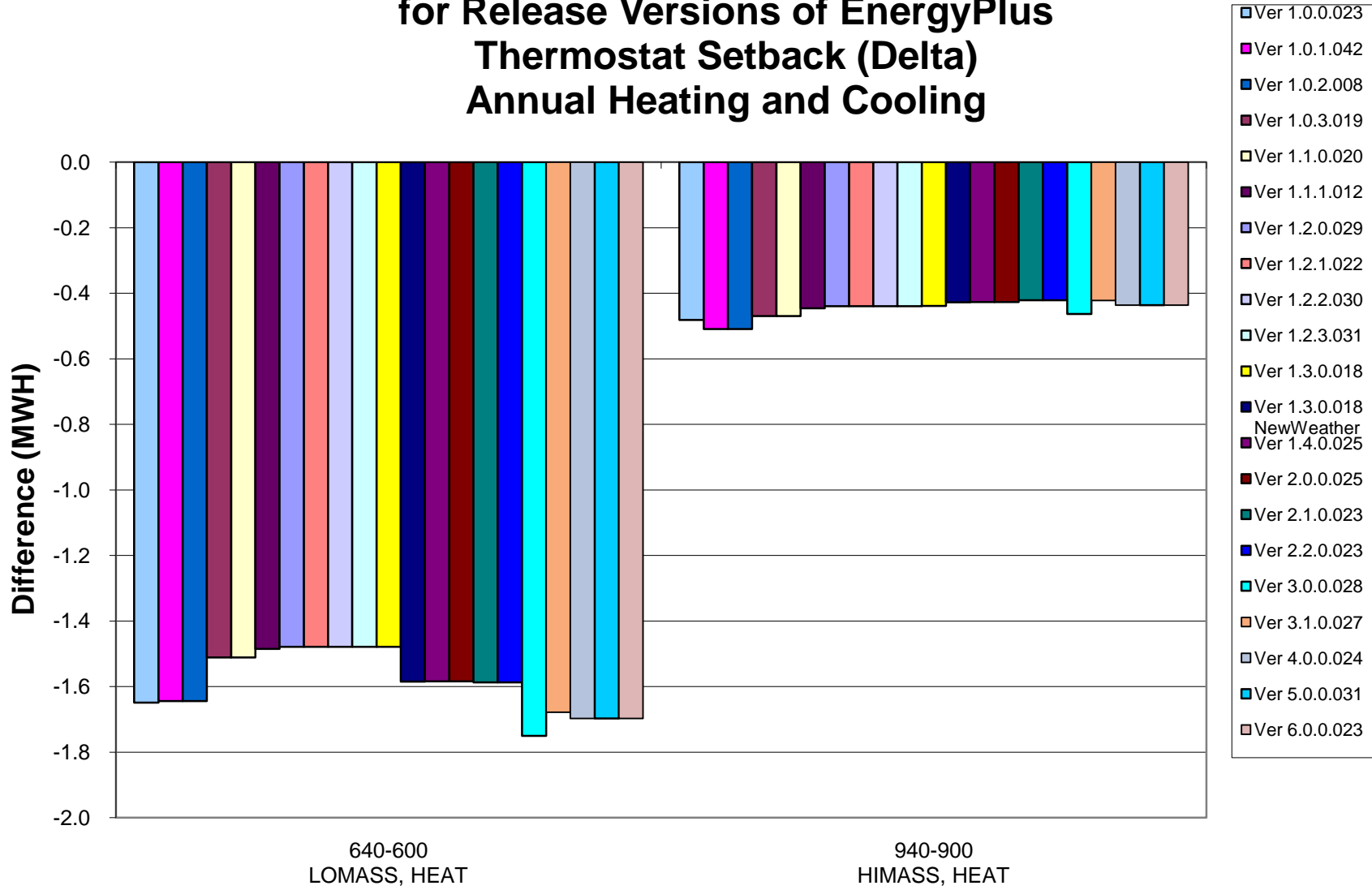

Standard 140-2007 Comparison for Release Versions of EnergyPlus Thermostat Setback (Delta) Peak Heating

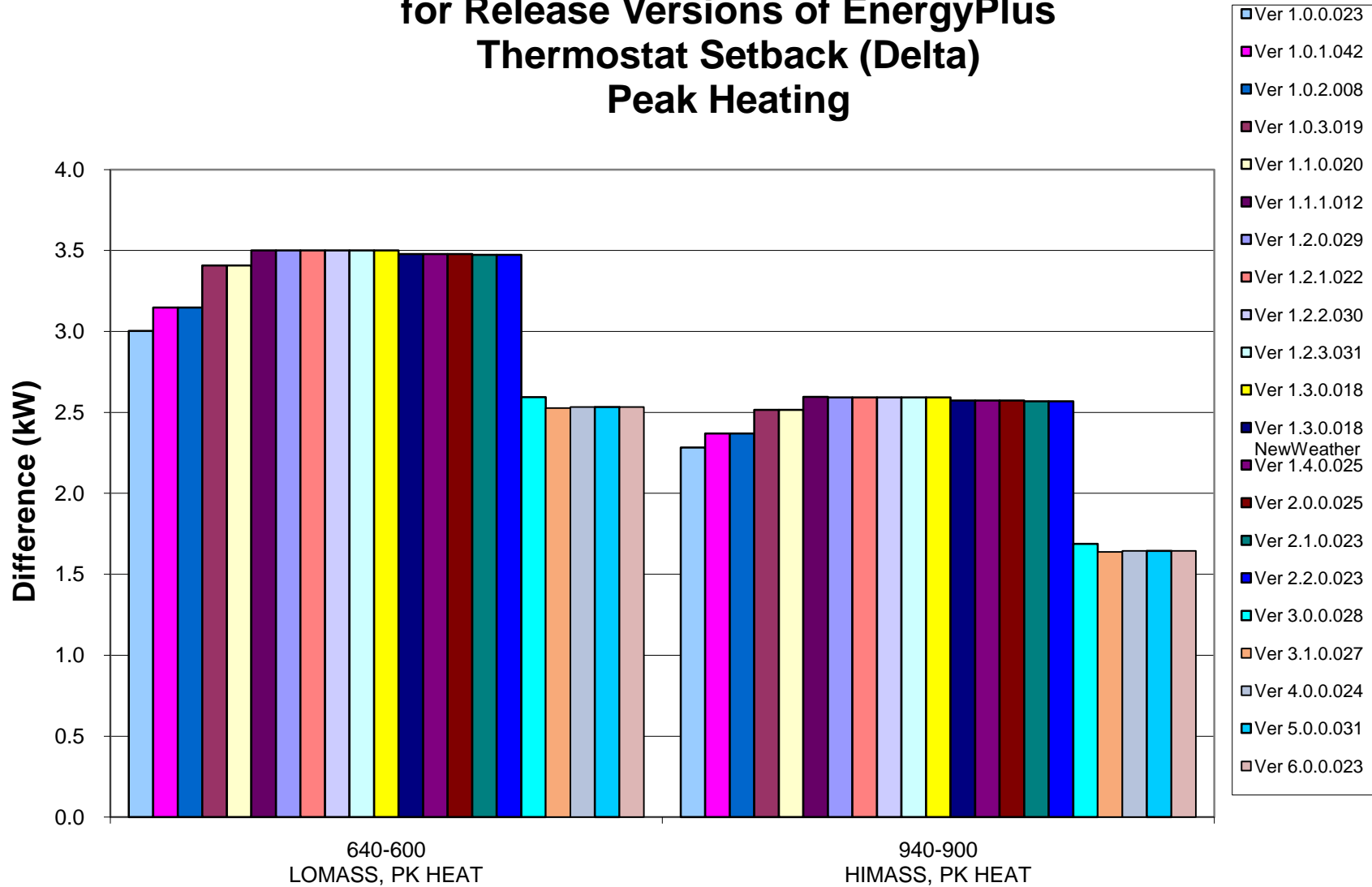

Standard 140-2007 Comparison for Release Versions of EnergyPlus Sunspace (Delta) Annual Heating and Cooling

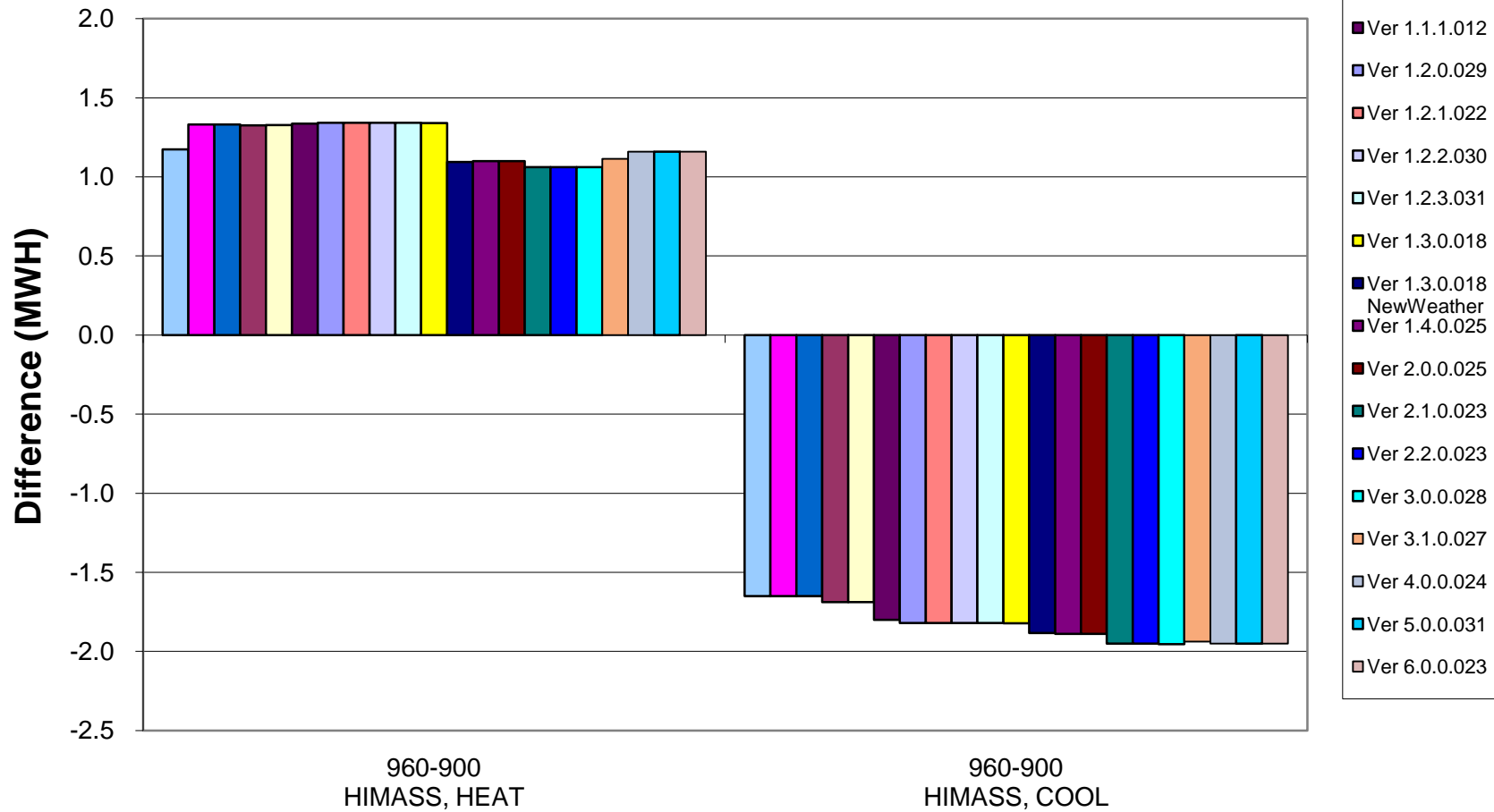

Standard 140-2007 Comparison for Release Versions of EnergyPlus Sunspace (Delta) Peak Heating and Cooling

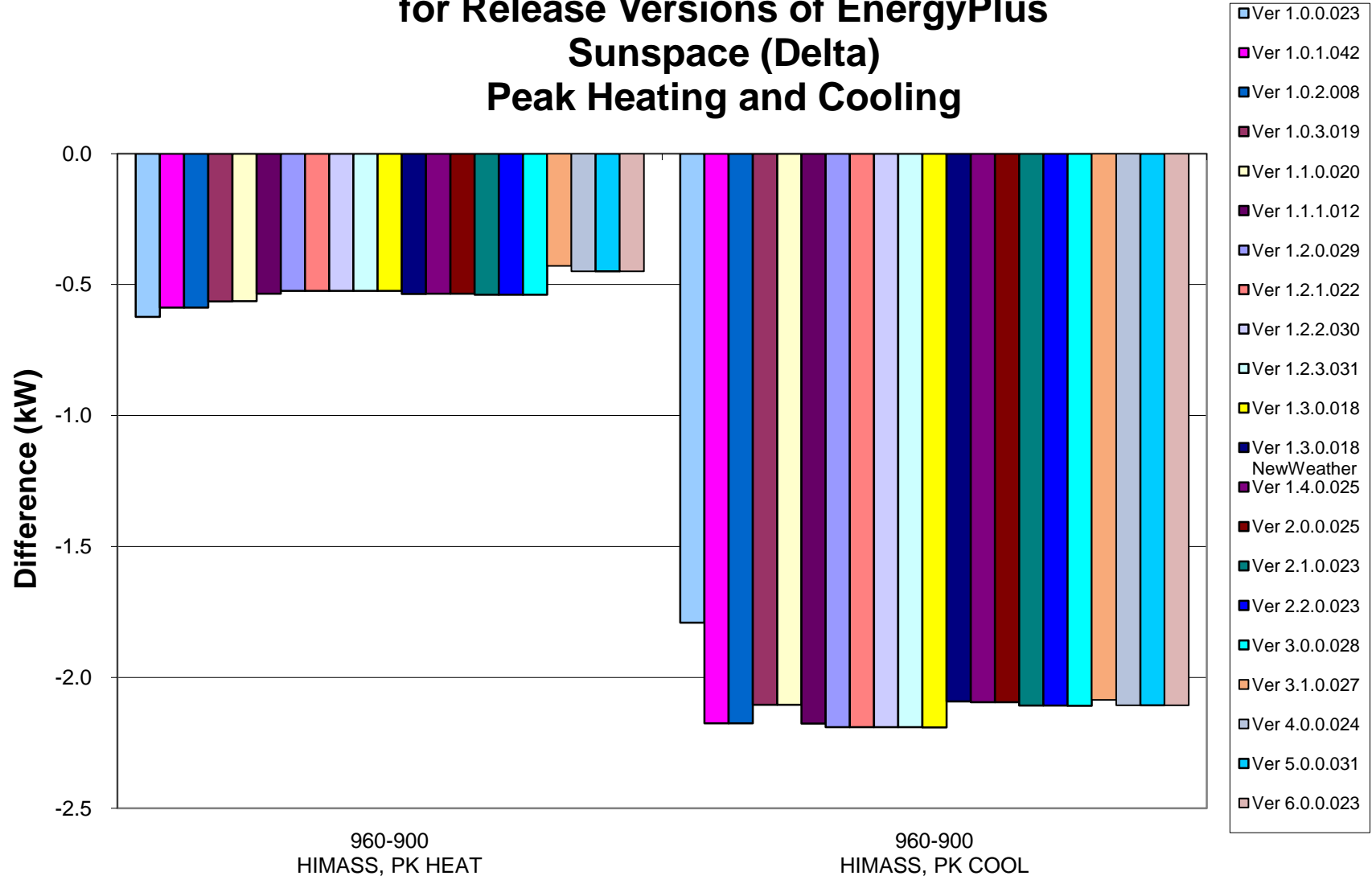

Appendix F

ANSI/ASHRAE Standard 140-2007 Output Form – Modeling Notes

STANDARD 140 OUTPUT FORM – MODELING NOTES

SOFTWARE: EnergyPlus
VERSION: 6.0.0.023

Simulated Effect:

Inside and outside convection algorithm

Optional Settings or Modeling Capabilities:

SurfaceConvectionAlgorithm:Inside = Simple
SurfaceConvectionAlgorithm:Inside = TARP
SurfaceConvectionAlgorithm:Inside = Ceiling Diffuser
SurfaceConvectionAlgorithm:Inside = AdaptiveConvectionAlgorithm

SurfaceConvectionAlgorithm:Outside = SimpleCombined
SurfaceConvectionAlgorithm:Outside = TARP
SurfaceConvectionAlgorithm:Outside = MoWitt
SurfaceConvectionAlgorithm:Outside = DOE-2
SurfaceConvectionAlgorithm:Outside = AdaptiveConvectionAlgorithm

Setting or Capability Used:

SurfaceConvectionAlgorithm:Inside = TARP
SurfaceConvectionAlgorithm:Outside = DOE-2

Physical Meaning of Option Used:

The DOE-2 calculation method is used rather than the more simple ASHRAE methodology.

Simulated Effect:

Solar distribution effects for shade surfaces

Optional Settings or Modeling Capabilities:

SOLAR DISTRIBUTION = MinimalShadowing
SOLAR DISTRIBUTION = FullExterior
SOLAR DISTRIBUTION = FullInteriorAndExterior
SOLAR DISTRIBUTION = FullExteriorWithReflections
SOLAR DISTRIBUTION = FullInteriorAndExteriorWithReflections

Setting or Capability Used:

SOLAR DISTRIBUTION = FullInteriorAndExterior

Physical Meaning of Option Used:

Full interior and exterior shadow calculations are performed each hour.

Simulated Effect:

Calculating resulting zone temperature.

Optional Settings or Modeling Capabilities:

*Zone Capacitance Multiplier: Research Special,
Temperature capacity Multiplier > 0,
Humidity Capacity Multiplier > 0,
Carbon Dioxide Capacity Multiplier > 0*

Setting or Capability Used:

*Let default to
Zone Capacitance Multiplier: Research Special
Temperature capacity Multiplier = 1,
Humidity Capacity Multiplier = 1,
Carbon Dioxide Capacity Multiplier = 1*

Physical Meaning of Option Used:

Used for stability in predictor corrector step by increasing reactive capacity of zone

Simulated Effect:

Various variables used to describe properties of surfaces.

Optional Settings or Modeling Capabilities:

Visible Absorptance = 0.0 to 1.0

Setting or Capability Used:

Visible Absorptance = Solar Absorptance = 0.6

Physical Meaning of Option Used:

Solar Absorptance – property of surface describing ability to absorb incident solar radiation

Simulated Effect:

Simulation time increment.

Optional Settings or Modeling Capabilities:

TimeStep = whole number between 1 and 60 evenly divisible into 60

Setting or Capability Used:

TimeStep = 4

Physical Meaning of Option Used:

The simulation time increment is 15 minutes. Outputs were set to report hourly.

Simulated Effect:

Frequency of solar and shadow calculations.

Optional Settings or Modeling Capabilities:

ShadowCalculation >= 1 (default = 20, every 20 days)

Setting or Capability Used:

ShadowCalculation = 1

Physical Meaning of Option Used:

Solar and shadow calculations frequency done based on value set.

Simulated Effect:

Window properties for double pane glazing made of standard 1/8" (3mm) clear glass with 1/2" (13mm) air gap.

Optional Settings or Modeling Capabilities:

EnergyPlus requires window properties for front and back of window surface.

Setting or Capability Used:

Window properties were described as follows:

WindowMaterial:Glazing,

Glass Type 1,	!- Name
SpectralAverage,	!- Optical Data Type
,	!- Window Glass Spectral Data Set Name
0.003175,	!- Thickness {m}
0.86156,	!- Solar Transmittance at Normal Incidence
0.07846,	!- Front Side Solar Reflectance at Normal Incidence
0.07846,	!- Back Side Solar Reflectance at Normal Incidence
0.91325,	!- Visible Transmittance at Normal Incidence
0.08200,	!- Front Side Visible Reflectance at Normal Incidence
0.08200,	!- Back Side Visible Reflectance at Normal Incidence
0.0,	!- Infrared Transmittance at Normal Incidence
0.84,	!- Front Side Infrared Hemispherical Emissivity
0.84,	!- Back Side Infrared Hemispherical Emissivity
1.06;	!- Conductivity {W/m-K}

WindowMaterial:Gas,

Air Space Resistance,	!- Name
AIR,	!- Gas Type
0.013;	!- Thickness {m}

Construction,

Double Pane Window,	!- Name
Glass Type 1,	!- Outside Layer
Air Space Resistance,	!- Layer 2
Glass Type 1;	!- Layer 3

Physical Meaning of Option Used:

Description of window properties for double pane clear glass window for determining solar and conduction heat gain.

Simulated Effect:

Ground Reflectance.

Optional Settings or Modeling Capabilities:

Site:GroundReflectance = 0.0 to 1.0

Setting or Capability Used:

Site:GroundReflectance = 0.20

Physical Meaning of Option Used:

Property of ground surface describing amount of incident solar that is reflected.
